



PROPANE POWERED BURNISHER

MODELS:

(24"-18 HP) **1.022-322.0**

(27"-18 HP) **1.022-323.0**



Read these instructions before using the machine.



MACHINE DATA LOG/OVERVIEW

Model:	_____
Date of Purchase:	_____
Serial Number:	_____
Dealer:	_____
Address:	_____
Phone Number:	_____
Sales Representative:	_____

READ THIS MANUAL!

This manual has important information for the use and safe operation of this machine. Failure to read this manual prior to operating or attempting any service or maintenance procedure to your machine could result in injury to you or to other personnel, damage to the machine or to other property could occur as well. You must have training in the operation of this machine before using it. If your operator(s) cannot read English, have this manual explained fully before attempting to operate this machine.

Si usted es el operador y no puede leer inglés, tenga el manual explicado totalmente a usted antes de manejar o de mantener esta máquina.

All directions given in this manual are as seen from the operator's position at the rear of the machine.

This Owner's Manual/Safety Procedures Guide has been prepared for the promotion of educational purposes only and Kärcher does not claim or assume any responsibility for the operator's actions or safety. To be completely aware of what local authorities may require, contact the Fire Marshal of your community.

For new manual go to: www.windsorkarchergroup.com/en

! WARNING: It is the owner/operator's responsibility to ensure that the air-exchange system installed in any location where a propane floor care machine is being operated is of sufficient capacity and quality to support the use of such a machine. OSHA and other County, State, or Federal Agencies publish guidelines on this subject that are usually most readily found in the possession of the respective owners and/or parent companies of any location or chain of locations. Failure on the part of the owner/operator to ensure that a propane floor care machine can be operated safely in a given location may lead to injury, sickness or even loss of life.

Warranty Registration

Thank you for purchasing a Kärcher North America product. Warranty registration is quick and easy. Your registration will allow us to serve you better over the lifetime of the product.

To register your product go to:
<http://warranty.karcherna.com/>
For customer assistance:
1-800-444-7654



TABLE OF CONTENTS

<i>Machine Data Log/Overview</i>	2
<i>Table Of Contents</i>	3
<i>How To Use This Manual</i>	4
<i>Introduction</i>	5

Parts List

<i>Propane Burnisher</i>	4-1
--------------------------------	-----

Safety

<i>Hazard Intensity Level</i>	1-1
<i>Important Safety Instructions</i>	1-1
<i>Propane Safety Information</i>	1-3
<i>Recommended Purge Procedures</i>	1-4
<i>Refilling & Storing Propane Tank</i>	1-5
<i>Engine Emissions & Co Safety</i>	1-6
<i>Potential Effects Of Co Exposure</i>	1-7
<i>Methods To Reduce The Risks Of Co Poisoning</i>	1-9
<i>Air Quality Monitoring</i>	1-11
<i>Maintenance Of Equipment</i>	1-13
<i>Co Safety Equipment Available</i>	1-13

Operations

<i>Preparing The Machine For Use</i>	2-1
<i>Starting The Engine</i>	2-2
<i>Stopping The Engine</i>	2-2

Maintenance

<i>Emission Control Information</i>	3-1
<i>General Maintenance And Adjustments</i>	3-1
<i>Fuel Control System</i>	3-1
<i>Pad Replacement</i>	3-1
<i>Belt Replacement</i>	3-2
<i>Recommended Oil Change Intervals</i>	3-2
<i>Troubleshooting</i>	3-3

HOW TO USE THIS MANUAL

This manual contains the following sections:

- HOW TO USE THIS MANUAL
- SAFETY
- OPERATIONS
- MAINTENANCE
- PARTS LIST

The HOW TO USE THIS MANUAL section will tell you how to find important information for ordering correct repair parts.

Parts may be ordered from authorized dealers. When placing an order for parts, the machine model and machine serial number are important. Refer to the MACHINE DATA box which is filled out during the installation of your machine. The MACHINE DATA box is located on the inside of the front cover of this manual.

Model: _____
Date of Purchase: _____
Serial Number: _____
Dealer: _____
Address: _____
Phone Number: _____
Sales Representative: _____

The SAFETY section contains important information regarding hazard or unsafe practices of the machine. Levels of hazards is identified that could result in product or personal injury, or severe injury resulting in death.

The OPERATIONS section is to familiarize the operator with the operation and function of the machine.

The MAINTENANCE section contains preventive maintenance to keep the machine and its components in good working condition.

The PARTS LIST section contains assembled parts illustrations and corresponding parts list. The parts lists include a number of columns of information:

- **REF** – column refers to the reference number on the parts illustration.
- **PART NO.** – column lists the part number for the part.
- **PRV NO.** - Reference No.
- **QTY** – column lists the quantity of the part used in that area of the machine.
- **DESCRIPTION** – column is a brief description of the part.
- **SERIAL NO. FROM** – If this column has an (*) and a Reference number, see the SERIAL NUMBERS page in the back of your manual. If column has two asterisk (**), call manufacturer for serial number. The serial number indicates the first machine the part number is applicable to. The main illustration shows the most current design of the machine. When a boxed illustration is shown, it displays the older design.
- **NOTES** – column for information not noted by the other columns.

NOTE: If a service or option kit is installed on your machine, be sure to keep the KIT INSTRUCTIONS which came with the kit. It contains replacement parts numbers needed for ordering future parts.

NOTE: The number on the lower left corner of the front cover is the part number for this manual.

INTRODUCTION

This propane floor care equipment is manufactured in two basic concepts: the burnisher and the floor stripper. Both of these designs are truly PORTABLE equipment. Propane burnishers are best defined as ultra high speed burnishers with the staying power to produce superior high gloss floor surfaces. Upon contact with the floor, the burnisher should always be kept moving. The speed at which you walk will determine the results that you will obtain. Slower speeds create more heat and therefore more shine. Kärcher recommends a moderate pace for best results and safe operation. **NEVER RUN WITH THE BURNISHER!!** While a credible shine will still result, the danger of trying to stop the machine in an emergency situation is unacceptable. When buffing, avoid loose tile, electric outlets, door thresholds and any object which may come in contact with the pad other than the floor itself. **REMEMBER**, the pad is turning very rapidly.

Proper care and maintenance will protect your investment and keep your machine serving you for many years to come. It is essential that these issues are closely followed:

CAUTION:

Overfilling the propane tank is the **number one cause of problems** with a propane machine. This can cause the engine to run poorly or not at all. In addition, overfilling allows liquid propane to enter the fuel control system, possibly ruining the lock off / regulator assembly. This voids the warranty on affected parts of the machine. To avoid problems, read and understand fully, the section "**Filling and Storing Propane Tanks.**"

OVERHEATING is a major cause of engine failure. Keep the cooling air bonnet filter clean. Protect your machine; don't allow wax dust/lint to build up on the cooling fins of the engine cylinder(s). A good high pressure spray wash directed at the fins when the engine is cold will prevent this from happening.

LOW OIL AND DIRTY OIL account for most of the other failures. It is recommended changing the oil on a regular schedule, perhaps exceeding that which is found in the engine manufacturers' manual. Checking the oil daily, before putting the machine to work, is a good habit to get into and could save you the downtime and expense of replacing the engine due to oil starvation. **AFTER AN OIL CHANGE, MAKE SURE YOU HAVE REPLACED THE OIL SUPPLY BEFORE RESTARTING THE ENGINE.**

SAFETY

HAZARD INSTENSITY LEVEL

The following symbols are used throughout this guide as indicated in their descriptions:

DANGER:

DANGER means: Severe bodily injury or death can occur to you or other personnel if the DANGER statements found on this machine or in this Owner's Manual are ignored or are not adhered to. Read and observe all DANGER statements found in this Owner's Manual and on your machine.

WARNING:

WARNING means: Injury can occur to you or to other personnel if the WARNING statements found on your machine or in this Owner's Manual are ignored or are not adhered to. Read and observe all WARNING statements found in this Owner's Manual and on your machine.

CAUTION:

CAUTION means: Damage can occur to the machine or to other property if the CAUTION statements found on your machine or in this Owner's Manual are ignored or are not adhered to. Read and observe all CAUTION statements found in this Owner's Manual and on your machine.

IMPORTANT SAFETY INSTRUCTIONS

When using a propane powered appliance, basic precaution must always be followed, including the following:

DANGER:

- Failure to read the Owner's Manual prior to operating or attempting any service or maintenance procedure to your machine could result in injury to you or to other personnel; damage to the machine or to other property could occur as well. You must have training in the operation of this machine before using it. If you or your operator(s) cannot read English, have this manual explained fully before attempting to operate this machine.
- Moving parts of this machine can cause serious injury and/or damage. Do not allow contact of clothing, hair, hands, feet, or other body parts with the rotating pad. Keep other people away from the machine while it's in operation.
- Injury to the operator or bystanders could occur if the machine's power is on while changing the buffing pad or making machine adjustments. Never try to change the buffing pad or attempt to make machine adjustments while the engine is running.
- Cigarette lighters, pilot lights and any other sources ignition can create an explosion if it comes in contact with propane. Propane is a highly flammable fuel. All sources of ignition should be extinguished or removed entirely if possible from the work area. **DO NOT SMOKE** in the vicinity of a propane burnisher.
- This machine emits carbon monoxide. Asphyxiation could occur if the unit is used in an area with poor or inadequate ventilation. Operate machine in a well ventilated area only. If a headache develops, shut off the machine. Have it checked for carbon monoxide emissions by a qualified shop before using it again.
- Dangerous carbon monoxide emissions from this machine are greatly increased due to a dirty combustion air cleaner. Follow the engine's manufacturer's air cleaner service instructions.
- Propane is highly flammable. If you smell propane gas, shut off the machine and move it outside. Determine the source of the leak before using it again. **NEVER** vent propane gas inside a building. It is **UNLAWFUL** to store a propane bottle inside a building.

WARNING:

- Long or continuous exposure to high noise levels may cause permanent hearing loss. Always wear hearing protection while using this machine.
- Injury to the eyes and/or body can occur if protective clothing and/or equipment is not worn while using this machine. Always wear safety goggles and safety clothing while using this machine.
- Severe burn or injury could occur if you touch the hot muffler or exhaust pipe. **DO NOT TOUCH THE HOT MUFFLER OR EXHAUST PIPE.**
- Any alterations or modifications of this machine could result in damage to the machine or injury to the operator or other bystanders. Alterations or modifications not authorized by the manufacturer voids any and all warranties and liabilities.
- To avoid injury or property damage, do not leave the machine where it can be tampered with or started by persons untrained in its operation. You must have training in the operation of this machine before using it. **DO NOT** leave the machine running unattended.
- Substantial damage to the floor, the machine, or personnel may result if the machine is operated with the pad off center, damaged or missing. Do not operate the machine if the pad is off center, damaged or missing.
- Operating a machine that has loose parts could result in injury or property damage. Do not operate this machine if there are loose parts. Inspect the machine for loose parts frequently. This will promote safe operation and a long life for the machine.
- Vibration from machinery may cause numbness or tingling of the fingers in certain people. Smoking, dampness, diet, and heredity may contribute to the symptoms. Wearing warm clothing, gloves, exercising and refraining from smoking can reduce the effects of vibration. If the symptoms still persist, discontinue operation of the machine.

CAUTION:

- Overfilling the propane tank is the number one cause of problems with a propane machine. This can cause the engine to run poorly or not at all. In addition, overfilling allows liquid propane to enter the fuel control system, possibly ruining the lock off / regulator assembly. This voids the warranty on affected parts of the machine. To avoid problems, read and understand fully, the section "Filling and Storing Propane Tanks."
- **OVERHEATING** is a major cause of engine failure. Keep the cooling air bonnet filter clean. Protect your machine; don't allow wax dust/lint to build up on the cooling fins of the engine cylinder(s). A good high pressure spray wash directed at the fins when the engine is cold will prevent this from happening.
- **LOW OIL AND DIRTY OIL** account for most of the other failures. It is recommended changing the oil on a regular schedule, perhaps exceeding that which is found in the engine manufacturers' manual. Checking the oil daily, before putting the machine to work, is a good habit to get into and could save you the downtime and expense of replacing the engine due to oil starvation. **AFTER AN OIL CHANGE, MAKE SURE YOU HAVE REPLACED THE OIL SUPPLY BEFORE RESTARTING THE ENGINE.**

SAFETY

PROPANE SAFETY INFORMATION

Facts About LP Gas – Propane

As a fuel, Propane gas is unmatched for both safety and dependability. It has been used as a domestic household fuel for over half a century, and for over thirty years as an internal combustion engine fuel. Propane is a highly flammable fuel that is contained under pressure as a liquid. Vaporized gas has a similar explosive force to gasoline and mixtures as low as 2% LP Gas to air may be ignited in a closed environment. Care should be exercised to avoid escaping vapor as it can freeze skin and cause frost bite. Vaporized fuel is heavier than air and will collect in the lowest confined space available.

Facts About Propane Tanks

Propane tanks are constructed according to ASME or Federal DOT #4ET20 pressure safety codes. Including the tank, all valves and fittings are UL Listed. Propane gas is noncorrosive and will not rust the inside of a tank. Should the tank exterior become damaged or rusted, discontinue use. **DO NOT** tamper with tank gauges or safety relief valves. **NEVER** use a tank not intended for use with a propane burnisher. **DO NOT** substitute tanks that are used with a barbecue grill, etc. It is recommended having propane tanks tested once a year by an authorized National LP Gas Association propane dealer.

The fuel tank is supplied directly from the manufacturer and is void of fuel. This tank must be purged at the time of the first fill. Local fuel vendors should be familiar with this operation and will provide this service.

RECOMMENDED PURGE PROCEDURES

How to purge new LP-Gas Burnisher cylinders equipped with the Overfill Prevention Device:

New containers may contain vapor, air, or other contaminants. It is essential that these be removed before filling the container and placing it into service. Air in the container will cause abnormally high pressure, with the result that the pressure relief valve may open. Air in the system is also likely to cause lean mixture, making ignition difficult. If a cylinder is suspected of being depressurized or open to the atmosphere for a period of time, it must be re-purged as if it were a new container.

To purge a container, the following steps should be taken.

1. Purging of containers should be performed in an approved area (see NFPA 05 8) using NPGA #13 3.89(a) procedure.
2. Determine if the container pressure is zero. Should the cylinder contain only pressurized air, the air may be vented directly to the atmosphere through the service valve using an adapter and the outage valve. Pressurize the container to approximately 15 psig with LP-gas vapor. Never purge with liquid LP-gas! To do so will cause the moisture vapor to chill and remain in the cylinder. LP gas liquid also expands 270 times to vapor making the purge process ineffective. Use LP-gas vapor only!
3. Make the connection to the quick coupler (A purge manifold system is most effective). Fully open the cylinder service valve as well as the outage valve. Vent to a safe atmosphere. A vent stack is recommended.
4. On Overfill Prevention Device cylinders, the purge time is increased as a result of the new valve design. Opening the outage valve will help improve the speed of the purge.
5. Repeat #3 and #4 for a total of FIVE purges.
6. Re-pressurize the container with odorized LP-gas vapor to 15 psig.
7. The container is now ready to be filled with LP-gas.
8. Once filled, check all fittings and tank openings for leaks using an approved leak detector solution.
9. The container is now ready to be placed in service. Add DOT and OSHA labels.

Symptoms of a non-purge cylinder:

- Relief valve opens due to over pressurized cylinder creating hazardous situation.
- Moisture in the cylinder.
- Burnisher operates initially but shuts down when fuel mixture becomes too lean.

SAFETY

REFILLING & STORING PROPANE TANKS

The NFPA Technical Committee prohibits the storage of such containers in buildings. There are few exceptions to this rule. In other words, propane tanks should NOT be stored in buildings used by the public or frequented by anyone passing through or who is working in the building. Full or empty, never leave tanks in small enclosed areas. The tank(s) must be in a secure, tamper-proof storage enclosure that provides safety from accident or vandalism. **PROPANE TANKS SHOULD ALWAYS BE TRANSPORTED, INSTALLED AND USED IN AN UPRIGHT POSITION.**

OVERFILLING PROPANE TANKS IS HAZARDOUS. The tank should **NEVER** be completely filled with liquid propane. 80% of the total tank volume is to be considered at **ALL** times as full. **EXPANSION MUST BE ALLOWED FOR.** Propane Burnisher tanks are equipped with a fixed liquid level gauge which contacts the liquid level at 80% of container capacity, allowing 20% for expansion. The top part of this device must be unscrewed counterclockwise so that vapor can escape through the small hole it its side, as the tank is refilled. When the escaping vapor starts to give way to liquid, the device must be quickly closed and the propane nozzle turned off.

⚠ CAUTION:

The engine and the fuel system on your floor care machine are designed to run on fuel vapor, not fuel liquid. Overfilling the propane tank will result in damaging the lock off and/or regulator. This will **VOID** the **WARRANTY** on these components.

ENGINE EMISSIONS AND CO SAFETY

The purpose of this document is to provide information on:

- The potential effects of CO exposure
- The methods to reduce the risk of CO poisoning
- The methods used to determine the amount of potential exposure to CO produced by equipment

▲ DANGER:

All LPG (Liquid Propane Gas) powered engines, including this engine, produce Carbon Monoxide (CO). It is a FATAL POISON that is a colorless, odorless, tasteless, and non-irritating gas. It is produced by incomplete combustion of carbonaceous material such as propane (LPG).

Failure to provide for proper venting of CO produced during the operation of combustion powered engines may result in SERIOUS INJURY OR DEATH to the operator and those in the contaminated area.

The effects of CO can be experienced at different exposure levels, depending on the health of the individual. Conditions that affect the tolerance of the individual are smoking, age, temperature, humidity, and other conditions.

▲ WARNING:

Read and understand The Operators Manual completely before using this machine.

This document explains how CO produced can be managed to reduce the risk of carbon monoxide poisoning.

All distributors, owners, and operators should be aware of the potential effects of CO and the methods used to prevent over exposure.

We are dedicated to our customers, their safety, and providing information, services, and products that meet those needs.

Information provided in this document is current as of the date written January 2003.

SAFETY

POTENTIAL EFFECTS OF CO EXPOSURE

The information provided in the following overview has been condensed to provide the reader with a summary of the material presented.

Summary:

Potential Effects of CO Exposure

- Work place/industry guidelines for CO exposure limits vary substantially from region to region (OSHA) Permissible Exposure Limit (PEL) for CO is 50 ppm, as an 8-hour time weighted average.
- Definition of CO effects - The toxic effects of carbon monoxide in the blood is the result of tissue hypoxia (lack of oxygen). The severity depends on the state of activity of the individual and his tissue oxygen needs.

Methods to Reduce The Risks of CO Poisoning

- Air Exchange and CO Diffusion - CO does not mix with air on its own. Air currents can "stir" the CO and dilute the concentration values by mixing it with the available air. When using equipment over a large area in a short time "stirring" occurs as you walk.
- Application Considerations (Burnishing versus Stripping) - When activity is concentrated to a smaller area as in a stripping application, air "stirring" must be forced by use of fans to reduce the risk of high concentrations of CO.
- Air Quality Monitoring - Deployment of a monitor/detector is essential for the safe operation of any equipment that has the potential to produce CO.
- Room Size and Time Estimations - The concentration and volume of CO production, the size of the area and the amount of air exchange are factors involved with determining safe time limits for operation in a specific room size.
- Maintenance of Equipment - LPG engines are dependent on engine tune up, and air filter replacement. CO concentration (production) skyrockets when the air to fuel ratio becomes fuel rich. Follow the recommended Maintenance Schedule for the engine.
- Safety Equipment Available. - Three-way type catalytic converter to scrub CO, Hydro Carbons (HC), and Nitrous Oxide (NOx) from the engine exhaust providing the lowest possible emissions, high cubic feet per minute (CFM) fans (forced air mixing), and digital combustion analyzers for tail pipe emissions monitoring.

Work Place/Industry Guidelines For CO Exposure Limits

Limits for permissible exposure to CO vary substantially from region to region. City, State, and Industry requirements should be consulted prior to use of any equipment. The current Occupational Safety and Health Administration (OSHA) Permissible Exposure Limit (PEL) for CO is 50 ppm, as an 8-hour time weighted average (TW A). This is computed by making measurements at intervals over 8 hours, then adding the sums of the concentrations and the intervals, and dividing by 8 hours. For example:

Time	Interval	PPM	
8:00-9:00	1 HR	100	
9:00-10:00	1 HR	25	
10:00-11:00	1 HR	25	
11:00-12:00	1 HR	50	
12:00-1:00	1 HR	50	400ppm / 8HR=50ppm TW A
1:00-2:00	1 HR	50	
2:00-3:00	1 HR	50	
3:00-4:00	1 HR	50	
Time intervals =	8 HR	ppm =	400

The current National Institute for Occupational Health and Safety (NIOSH) has determined that concentrations above the (IDLH) recommended level for CO of 1,200 ppm is immediately dangerous to life and health. NIOSH defines the IDLH exposure level as the concentration that could result in irreversible health effects or death, or prevent escape. from the contaminated environment within 30 minutes.

Definition Of CO Effects

The toxic effects of carbon monoxide in the blood are the result of tissue hypoxia (lack of oxygen) carbon monoxide combines with hemoglobin to form carboxyhemoglobin. Since CO and oxygen react with the same group in the hemoglobin molecule, carboxyhemoglobin is incapable of carrying Oxygen. The affinity of hemoglobin for CO is 200 to 240 times greater than for oxygen. The extent of saturation of hemoglobin with CO depends on the concentration of the gas, the quantity of inspired air and on the time of exposure. The severity depends on the state of activity of the individual and his tissue oxygen needs.

According to Harrison's Principles of Internal Medicine 7th edition, no symptoms will develop at a concentration of 0.01 % CO (100ppm) in inspired air, since this will not raise blood saturation above 10 %. Exposure to 0.05% (500ppm) for 1 hour during light activity will produce a blood concentration of 20% carboxyhemoglobin and result in a mild or throbbing headache. Greater activity or longer exposure causes a blood saturation of 30 to 50 %. At this point head ache, irritability, confusion, dizziness, visual disturbance, nausea, vomiting, and fainting can be experienced. Exposure for one hour to concentrations of 0.1 % (1000ppm) in inspired air the blood will contain 50 to 80% carboxyhemoglobin which results in coma, convulsions, respiratory failure and death. On inhalation of high concentrations of CO, saturation of the blood proceeds so rapidly that unconsciousness may occur suddenly without warning.

SAFETY

METHODS TO REDUCE THE RISKS OF CO POISONING

- Air Exchange and CO Diffusion
- Application Considerations (Burnishing versus Stripping)
- Air Quality Monitoring
- Room Size and Time Estimations
- Maintenance of Equipment
- Safety Equipment Available

Air Exchange And CO Diffusion

The most reliable method to prevent CO Poisoning is to ensure all the CO produced is vented outside. With wood stoves or gas heaters this is performed with ductwork that carries the exhaust and CO outside. Non-stationary combustion type equipment must be used in such a way that CO is not allowed to rise to a harmful or dangerous level. CO does not readily dissipate or mix with air on its own. Air currents can "stir" the CO and dilute the concentration or ppm values by mixing it with the available air. When using equipment over a large area in a short time "stirring" occurs as you walk, or to say it another way, your Effective Operating Zone is large. When activity is concentrated to a smaller area as in a stripping application, the Effective Operating Zone is small, and "stirring" must be forced by the use of fans to increase the Effective Operating Zone and reduce high concentrations of CO. "Air" exchange rates (air exchange is defined as the exhausting of internal air to the external atmosphere), the size of the Effective Operating Zone, amount of CO produced, level of human activity, and the duration of exposure are all factors in the determination of the production of carboxyhemoglobin and the amount of CO blood saturation.

Application Considerations (Burnishing Versus Stripping)

When using equipment over a large area in a short time, as in most burnishing applications, your Effective Operating Zone is large. When activity is concentrated to a smaller area as in stripping applications, the Effective Operating Zone is small and stirring or CO mixing MUST be forced by the use of fans to increase the Effective Operating Zone and reduce high concentrations of CO. Caution: air mixing in itself may not be sufficient to reduce CO to a safe level. The Effective Operating Zone can be defined as the area covered in a given time.

**MODEL 1
NO AIR EXCHANGE | NO AIR MIXING (STRIP MODE)**

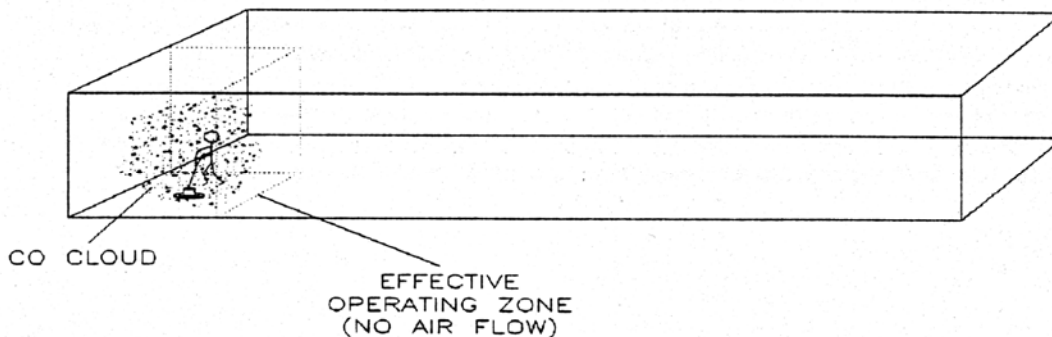

Stripping is quite a different type of operation than burnishing, and carries with it substantially more hazards, as stripping is a low movement operation compared to burnishing (less floor space for the same time). As shown in MODEL 1, the CO concentrations rise quicker as the "Effective Operating Zone" is a small area compared to the total building size.

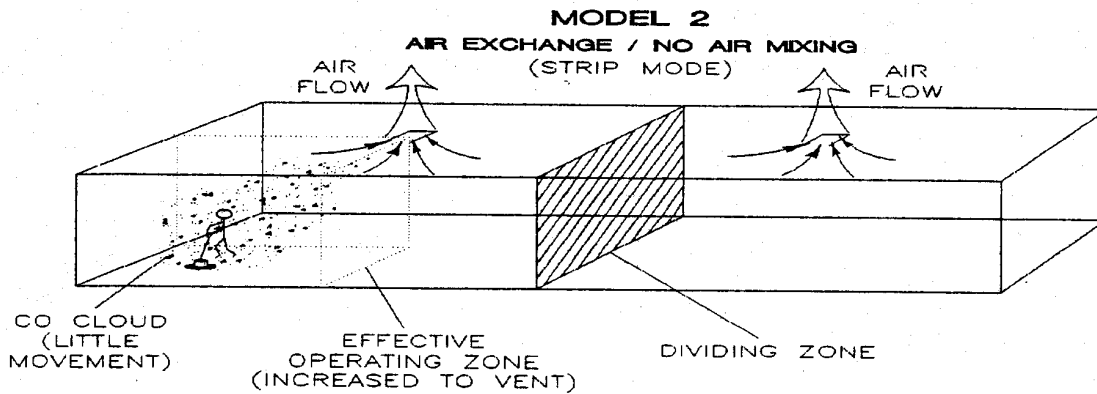

Notice the CO concentration and the Effective Operating Zone with air exchange. The CO cloud is still concentrated in a small area. Note the "Dividing Zone" shown above, this is the line where airflow changes direction. In Model 2, air changes are cut in 1/2 as little or no CO crosses the Dividing Zone to be exhausted.

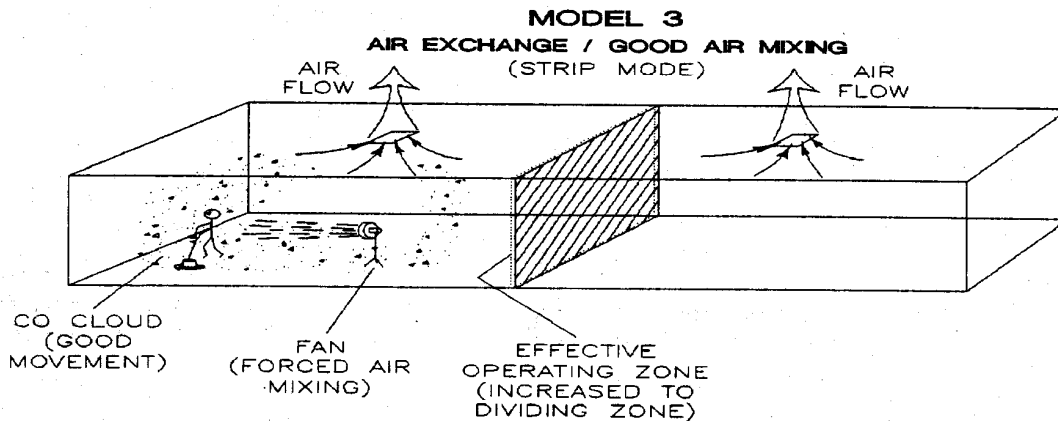

Notice the CO concentration and the Effective Operating Zone (Expanded to the Dividing zone) with air exchange and forced air mixing. The CO cloud is still concentrated on one side of the Dividing zone. Note the "Dividing Zone" shown above, this is the line where airflow changes direction. In Model 3, air changes are cut in 1/2 as little or no CO crosses the Dividing Zone to be exhausted.

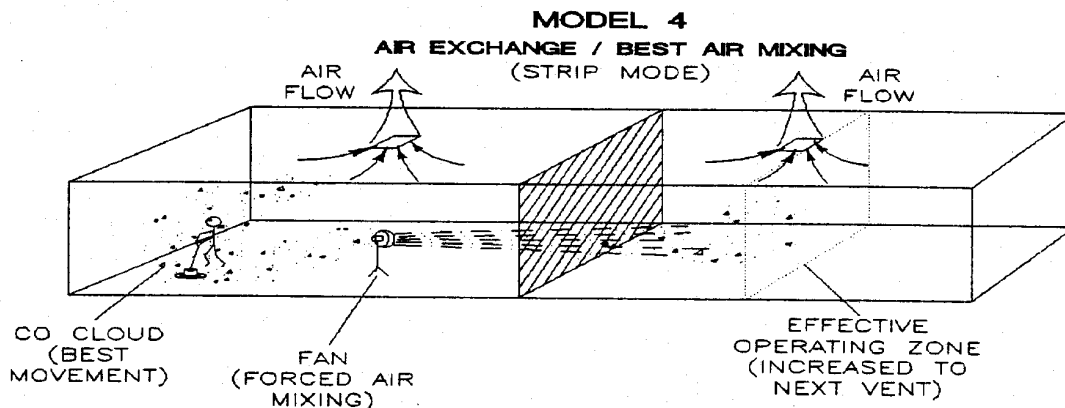

Notice the CO concentration and the Effective Operating Zone (Expanded through the Dividing zone to the second vent) with air exchange and forced air mixing through the dividing Zone. The CO cloud is diluted with the available air in the building. Note the "Dividing Zone" shown above, this is the line where airflow changes direction. In Model 4, air changes are full as forced air mixing has moved and mixed the CO between all air zones.

SAFETY

AIR QUALITY MONITORING

Warning - Deployment of a monitor/detector is essential for the safe operation of any equipment that has the potential to produce CO. CO sensors/detectors became available on the mass market around 1978. The main differences between the technologies involved are battery or electric and Semiconductor or Biomimetic types. Detectors for carbon monoxide (CO) are manufactured and marketed for use in either the home or occupational industrial settings. The detectors for home use are devices that will sound an alarm before CO concentrations in the home become hazardous. There is an Underwriters Laboratories, Inc., performance standard (UL 2034) for residential CO detectors. Detectors currently available on the market are battery-powered, plug-in, or hardwired. Some models incorporate a visual display of the parts per million (ppm) concentration of CO present in the home. For more information on CO detectors for home use, call the Consumer Product Safety Commission:

Commission Hotline at 1-800-638-2772

CO detectors for use in residential settings are not designed for use in workplace settings. Monitoring requirements in an occupational setting are different from monitoring requirements in the home. In the workplace, it is frequently necessary to monitor a worker's exposure to carbon monoxide over an entire work shift and determine the time-weighted average (TWA) concentration of the exposure. It may also be necessary to have carbon monoxide monitors with alarm capabilities in the workplace. The direct reading instruments are frequently equipped with audio and/or visual alarms and may be used for area and/or personal exposure monitoring. Some have microprocessors and memory for storing CO concentration readings taken during the day. It is significant to note that some of the devices mentioned for workplace CO monitoring are not capable of monitoring TWAs, and not all are equipped with alarms. The appropriate monitor must be chosen on an application-by-application basis. For more information on the availability of workplace CO monitors or their application, call the National Institute for Occupational Safety and Health at 1-800-35-NIOSH (1-800-356-4674).

Room Size and Time Estimations for Parts Per Million (PPM) CO

The fundamental factors in area CO levels involve:

- The concentration and volume of CO production
- The size of the area
- The amount of air exchange if any
- The amount of time CO is produced

Multiplying length, width, and height will determine the volume or cubic feet in a room. So an empty building 100ft by 100ft with a 10ft ceiling would be 100,000 cubic ft. in size. Any material that is in the room and takes space would reduce the cubic feet.

Air exchange is defined as the exhausting of internal air to the external atmosphere.

The Graph above depicts the relationships of air exchange to time and CO ppm with cubic feet area and percent CO emissions remaining constant.

Based on the CO production rates shown above the TWA would be exceeded in a 100 x 100 x 10 foot (empty) space after 3 hours with 2 air changes per hour. (Assumes no additional CO exposure during 8 hour time period)

8 Hour Time Weighted Average (OSHA Method)

1.5 %CO 100,000cf	Hours Operation	1	2	3	4	5	6	7	8
TWA (OSHA Method)	0 change/hr	34	103	206	343	514	719	959	1232
	1/2 change/hr	27	70	124	183	246	311	378	445
	1 changes/hr	22	51	84	118	152	186	220	255
	2 changes/hr	15	32	49	66	83	100	117	135

Based on the CO production rates shown above the TWA would be exceeded in a 100 x 100 x 10 foot (empty) space after 3 hours with 2 air changes per hour. (Assumes no additional CO exposure during 8 hour period)

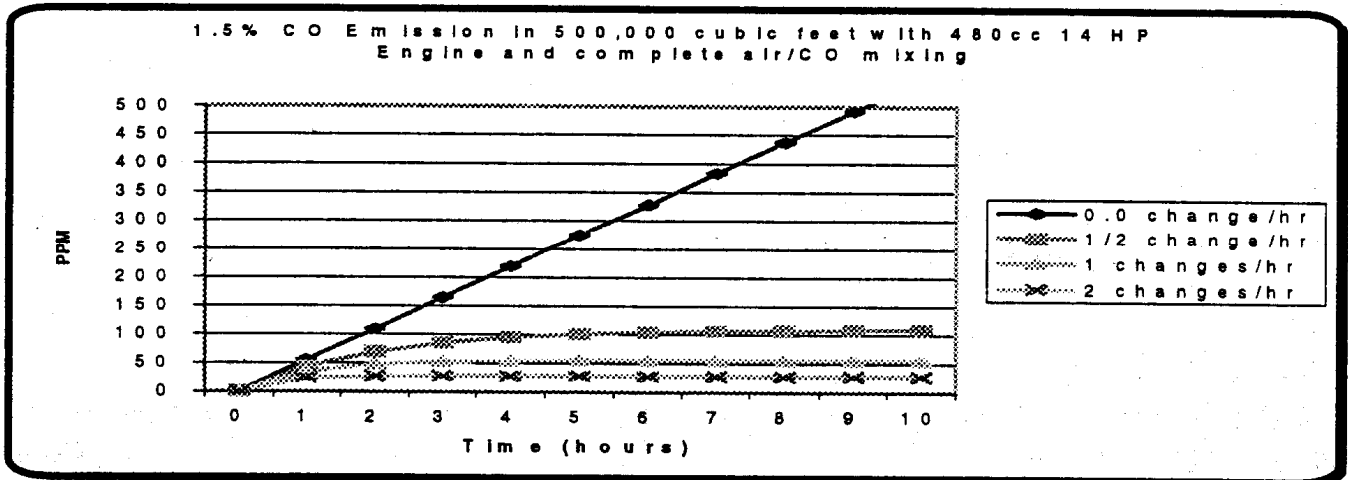

8 Hour Time Weighted Average (OSHA Method)

1.5 %CO 500,000cf	Hours Operation	1	2	3	4	5	6	7	8
TWA (OSHA Method)	0 change/hr	17	51	103	171	257	360	479	616
	1/2 change/hr	14	35	62	92	123	156	189	223
	1 changes/hr	11	26	42	59	76	93	110	127
	2 changes/hr	7	16	24	33	42	50	59	67

The Graph above depicts the relationships of air exchange to time and CO ppm with cubic feet area and percent CO emissions remaining constant.

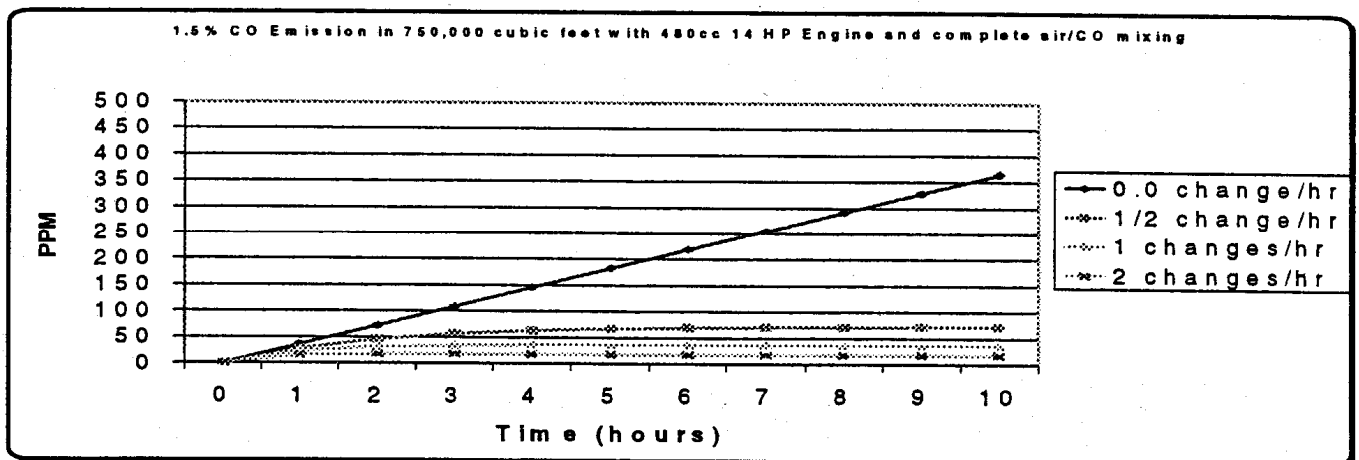

Based on the CO production rates shown above the TWA would be exceeded in a 100 x 500 x 10 foot (empty) space after 6 hours with 2 air changes per hour. (Assumes no additional CO exposure during 8 hour time period).

SAFETY

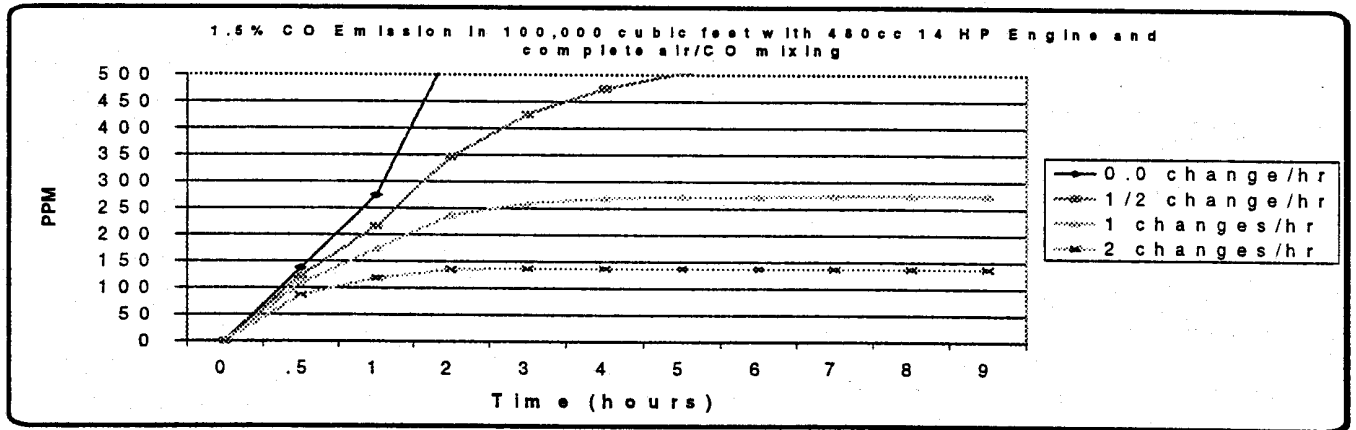

The Graph above depicts the relationships of air exchange to time and CO ppm with cubic feet area and percent CO emissions remaining constant.

8 Hour Time Weighted Average (OSHA Method)

1.5 %CO 750,000cf	Hours Operation	1	2	3	4	5	6	7	8
TWA (OSHA Method)	0 change/hr	5	14	27	46	69	96	128	164
	1/2 change/hr	4	9	16	24	33	42	50	59
	1 changes/hr	3	7	11	16	20	25	29	34
	2 changes/hr	2	4	7	9	11	13	16	18

Based on the CO production rates shown above the TWA would not be exceeded in a 100 x 750 x 10 foot (empty) space after 8 hours with 2 air changes per hour. (Assumes no additional CO exposure during 8 hour time period)

MAINTENANCE OF EQUIPMENT

⚠ WARNING:

The proper maintenance of equipment is vital to safe operation. LPG engines are dependent on engine tune up, and air filter replacement CO concentration (production) skyrockets when the air to fuel ratio becomes fuel rich. Follow the recommended Maintenance Schedule for the engine found in the Engine Operator/Owner Manual as well as the Maintenance And Adjustments schedule found in the Propane Floor Equipment Operator's Manual that were supplied with the equipment. Additional manuals may be obtained by contacting;

Kärcher North America at: 1-800-444-7654 or go to website www.windsorkarchergroup.com/en

CO SAFETY EQUIPMENT AVAILABLE

Three-way type catalytic converter to scrub CO, Hydro Carbons (HC), and Nitrous Oxide (NOx) from the engine exhaust providing the lowest possible emissions

High cubic feet per minute (PM) fans (forced air mixing)

Digital combustion analyzers for tail pipe emissions monitoring

PREPARING THE MACHINE FOR USE

NOTE: *Before using any type of powered equipment, proper safety dictates you should visually inspect it.*

1. Adjust the HANDLE to a comfortable height and tighten the bolts.
2. BONNET FILTER - Make sure the bonnet air filter atop the engine is clean. It should be changed hourly and thoroughly cleaned before reuse.
3. Check the engine OIL LEVEL. Screw the dipstick in to get a accurate reading.
4. Fill the tank following the instructions (see "Refilling and Storing Propane Tanks." section)
5. PAD AND PAD HOLDER - Inspect the condition of the pad and pad holder for wear and correct attachment. Ensure pad is clean and has at least a thickness of 1/3 inch. ALWAYS turn off engine to clean or replace pad.
6. TANK and FUEL LINES – Check for any sign of wear and tear, such as cracks or any corrosion. Replace hoses or correct any problems before operating the machine.
7. Screw the brass fuel line fitting onto the tank service valve hand tight only. This connection MUST be secure because the service valve has a safety valve inside it which will only open if the brass fuel line fitting is COMPLETELY seated into the service valve.

OPERATION

STARTING THE ENGINE

1. Plug in 12 volt starter cord on models so equipped.
2. We recommend setting the throttle on models with 12 volt starter to the following positions:
The Kawasaki twin cylinder engines are designed to be started in the IDLE throttle position. This creates a vacuum necessary to open the lock-off valve inside the regulator. Actuation of the throttle lever will keep the lock-off valve from opening and the engine from getting fuel so the engine will not start. Proper maintenance will insure easy starting.
3. Open (counterclockwise) the service valve on the propane tank about one and a half turns.
4. Ensure the burnisher is tilted back so that the pad is off the floor on all machines without a clutch.
5. Engage starter for a **MAXIMUM** of 5 to 6 seconds or until the engine fires. Serious starter damage will result if this is exceeded and the warranty may not apply.
6. Operate the engine at half throttle for approximately two minutes for proper warm-up. Then advance to full throttle for best results.

NOTE: If the engine refuses to start, see the Troubleshooting Guide.

STOPPING THE ENGINE

1. Close (clockwise) the service valve on the propane tank.
2. ALWAYS allow the engine to run until it stops from lack of fuel.

⚠ CAUTION:

ONLY IN AN EMERGENCY should the "kill switch" be used to stop the engine.

3. Disconnect the fuel line from the tank.
4. When you are finished with the machine, store the propane tank outside the building, in a SECURE place away from heat or direct sunlight.

EMISSION CONTROL INFORMATION

To protect the environment in which we will live, the manufacturer has incorporated (1) crankcase emission and (2) exhaust emission control systems (EM) in compliance with applicable regulations of the United States Environmental Protection Agency and California Air Resources Board.

1. **Crankcase Emission Control System.** A sealed-type crankcase emission control system is used to eliminate blow-by gases. The blow-by gases are led to the breather chamber through the crankcase. Then, it is led to the air cleaner. Oil is separated from the gases while passing through the inside of the breather chamber from the crankcase, and then returned back to the bottom of crankcase.
2. **Exhaust Emission Control System.** The exhaust emission control system applied to this engine consists of a carburetor and an ignition system having optimum ignition timing characteristics. The carburetor has been calibrated to provide lean air/fuel mixture characteristics and optimum fuel economy with a suitable air cleaner and exhaust system.

Tampering with Emission Control System Prohibited: Federal law and California State law prohibits the following acts or the causing thereof: (1) the removal or rendering inoperative by any person other than for purposes of maintenance, repair, or replacement, of any device or element at design incorporated into any new engine for the purpose of emission control prior to its sale or delivery to the ultimate purchaser or while it is in use, or (2) the use of the engine after such device or element of design has been removed or rendered inoperative by any person.

Among those acts presumed to constitute tampering involve the parts/systems listed below:

- Carburetor and internal parts
- Spark plugs
- Magneto or electronic ignition system
- Fuel filter element
- Air cleaner elements
- Crankcase
- Cylinder heads
- Breather chamber and internal parts
- Intake pipe and tube

GENERAL MAINTENANCE AND ADJUSTMENTS

FUEL CONTROL SYSTEM

To ensure personal safety, adjustments should ONLY be made by a qualified LPG system technician or an authorized service center, using an exhaust gas analyzer. Do not operate the machine if carbon monoxide levels exceed OSHA standards.

PAD REPLACEMENT

Tilt the machine back on its rear caster to reach the pad centering device. Turn the outer ring counterclockwise to remove it. Remove the old pad. Install the new pad by carefully centering it against the "harpoon hook" plastic gripper. Replace the center locking ring. Check rotation of the pad driver. Eccentricity of the pad should not exceed 1/4 of an inch.

MAINTENANCE

BELT REPLACEMENT

Tilt the machine on its side (observing the following precautions) and block securely.

NOTE: Do not tilt the machine (KAWASAKI twin cylinder) on its nose as this is where the carburetor is located. Turn the machine on either its left or right side.

1. Remove pad.
2. Use a suitable wrench to secure the top of the shaft and spin off the pad driver.
3. Remove old belt carefully and completely.
4. Install new belt and adjust the pressure of the tensioner
5. Reinstall pad driver.

RECOMMENDED OIL CHANGE INTERVALS

Do not exceed the 25 hour oil change interval. Oil changes more frequent than 25 hours will give even longer engine life. In any case, always use 30HD or 10W30 engine oil with all of the following ratings: SF, SG, and CC. The various engines have different oil sump capacities. Make sure the oil level is maintained at the "FULL" level.

SERVICE SCHEDULE

MAINTENANCE	25 HOUR	200 HOUR
Change engine oil.	*	
Check pad driver for loose parts.	*	
Check belt for wear or slippage	*	
Check engine pulley for tightness	*	
Check wheel bolts	*	
Check engine mount bolts	*	
Check handle bolts	*	
Check for leakage of engine oil at the various seals	*	
Return machine to authorized service center for overall checkup.		*

TROUBLESHOOTING

Note: *When trouble occurs be sure to check for simple causes, which at first may seem too obvious to be considered. For example, a starting problem could be caused by fuel starvation due to an empty propane cylinder or an unopened service valve. If you don't check for this, starter burnout could result.*

1. **SURGING IDLE** - To smooth out the engines' idle characteristics, adjustment is provided by an idle screw on the lower left side of the carburetor as viewed from the operator's position. The screw is bright steel and 1/4" in diameter with a Phillips head on it. Rotating the screw clockwise will increase the idle speed and this should cure the "surging idle". IF IT DOES NOT, call our customer service department for assistance.
2. **EXCESSIVE VIBRATION** - Look for the following possibilities:
 - Pad is off center. Remove and reinstall.
 - Pad Driver is cracked. (Possibly from striking a curb or bolt in the floor) Replace at once with a new part.
 - Bearings in Front End Assembly are worn. Place machine on its side where the muffler is mounted. Grip Pad Driver and move up, down and from side to side to check for slack in the bearings. If this is the case, then to affect a proper repair, the bearings should be replaced and possibly the shaft.
3. **ENGINE STARTS AND IDLES, BUT WILL QUIT AS THE THROTTLE IS ADVANCED** - It is possible that the propane tank's service valve is faulty. To check for this, close the valve completely and then reopen very slowly while you listen for a "click" when the gas begins to travel through the valve. If you hear this very slight noise, the valve is only partially opening. This allows enough gas through to start and idle the engine, but not enough for full throttle operation. As the throttle is increased, allowing more air to enter the intake, the engine will quit from fuel starvation. Call your dealer or the factory for instructions on where to have the service valve replaced. Meanwhile, to get by, you can continue to open the service valve until you don't hear a "click" and then the engine will run normally. IF IT DOES NOT, call our customer service department for further assistance.
4. **THE BURNISHER SEEMS TO RUN WELL BUT DIES DOWN WHEN THE PAD IS PLACED ON THE FLOOR OR SOON THEREAFTER** - Check for the same problem as in #3.
5. **EXCESSIVE NOISE FROM UNDER BURNISHER** - If this problem has developed after use of the machine from new, then the first place to check is the Tensioner. As a new belt wears in, it naturally stretches a bit and the tensioner will begin to rattle. Place the burnisher on its side (with the muffler down) and reset by taking up the slack in the belt and tighten the Tensioner.
6. **STARTER BARELY TURNS THE ENGINE OVER or THE SOLENOID JUST CLICKS ON 12 VOLT MODELS** -The battery is likely low in charge. This can be remedied by recharging the battery using a 12 volt battery charger at 4.12 amperes. The battery is located under the frame at the rear of the burnisher. The positive post is the one with the RED cable attached to it. Follow the instructions that came with the battery charger. REMINDER: this will continue to happen unless the burnisher's engine is run for sufficient time between starts to recharge the battery.
7. **KAWASAKI V-TWIN – ENGINE BEGINS TO BACKFIRE REGULARLY, SUDDENLY** - Check the sparkplug boots. One is likely cracked, possibly due to contacting a corner of a shelf or a door frame. Remove the sparkplug lead from the sparkplug and replace the boot. The engine should now run smoothly. IF IT DOES NOT contact our customer service department for further assistance.

MAINTENANCE

PROBLEM	CAUSE	SOLUTION
Surging idle	Carburetor out of adjustment	Adjust idle screw (1/4" dia bright steel, Phillips head) located on the lower left side of carburetor (Viewed from operators position). Rotate clockwise to increase idle speed. IF IT DOES NOT, call our customer service department for assistance.
Excessive Vibration	Pad is off center	Remove and reinstall
	Pad driver is cracked	Replace at with new pad driver
	Bearings in front end are worn	Bearings in Front End Assembly are worn. Place machine on its side where the muffler is mounted. Grip Pad Driver and move up, down and from side to side to check for slack in the bearings. If this is the case, then to affect a proper repair, the bearings should be replaced and possibly the shaft.
Engine starts and idles, but will quit as the throttle is advanced	Faulty service valve	To check for this, close the valve completely and then reopen very slowly while you listen for a "click" when the gas begins to travel through the valve. If you hear this very slight noise, the valve is only partially opening. This allows enough gas through to start and idle the engine, but not enough for full throttle operation. As the throttle is increased, allowing more air to enter the intake, the engine will quit from fuel starvation. Call your dealer or the factory for instructions on where to have the service valve replaced. Meanwhile, to get by, you can continue to open the service valve until you don't hear a "click" and then the engine will run normally. IF IT DOES NOT, call our customer service department for further assistance.

MAINTENANCE

PROBLEM	CAUSE	SOLUTION
The burnisher seems to run well but dies down when the pad is placed on the floor or soon thereafter		To check for this, close the valve completely and then reopen very slowly while you listen for a "click" when the gas begins to travel through the valve. If you hear this very slight noise, the valve is only partially opening. This allows enough gas through to start and idle the engine, but not enough for full throttle operation. As the throttle is increased, allowing more air to enter the intake, the engine will quit from fuel starvation. Call your dealer or the factory for instructions on where to have the service valve replaced. Meanwhile, to get by, you can continue to open the service valve until you don't hear a "click" and then the engine will run normally. IF IT DOES NOT, call our customer service department for further assistance.
Excessive noise from under burnisher	Belt has stretched or is loose	As a new belt wears in, it naturally stretches a bit and the tensioner will begin to rattle. Place the burnisher on its side (with the muffler down) and reset by taking up the slack in the belt and tighten the Tensioner.
Starter barely turns the engine over or the solenoid just clicks on 12 volt models	The battery is low in charge	Recharge the battery using a 12 volt battery charger at 4.12 amperes. The battery is located under the frame at the rear of the burnisher. The positive post has the RED cable attached to it. Follow the instructions that came with the battery charger. NOTE: this will continue to happen unless the burnisher's engine is run for sufficient time between starts to recharge the battery.
Engine suddenly begins to backfire regularly	Cracked spark plug boot	Remove the sparkplug lead from the sparkplug and replace the boot. The engine should now run smoothly. IF IT DOES NOT, contact our customer service department for further assistance.

PROPANE BURNISHER

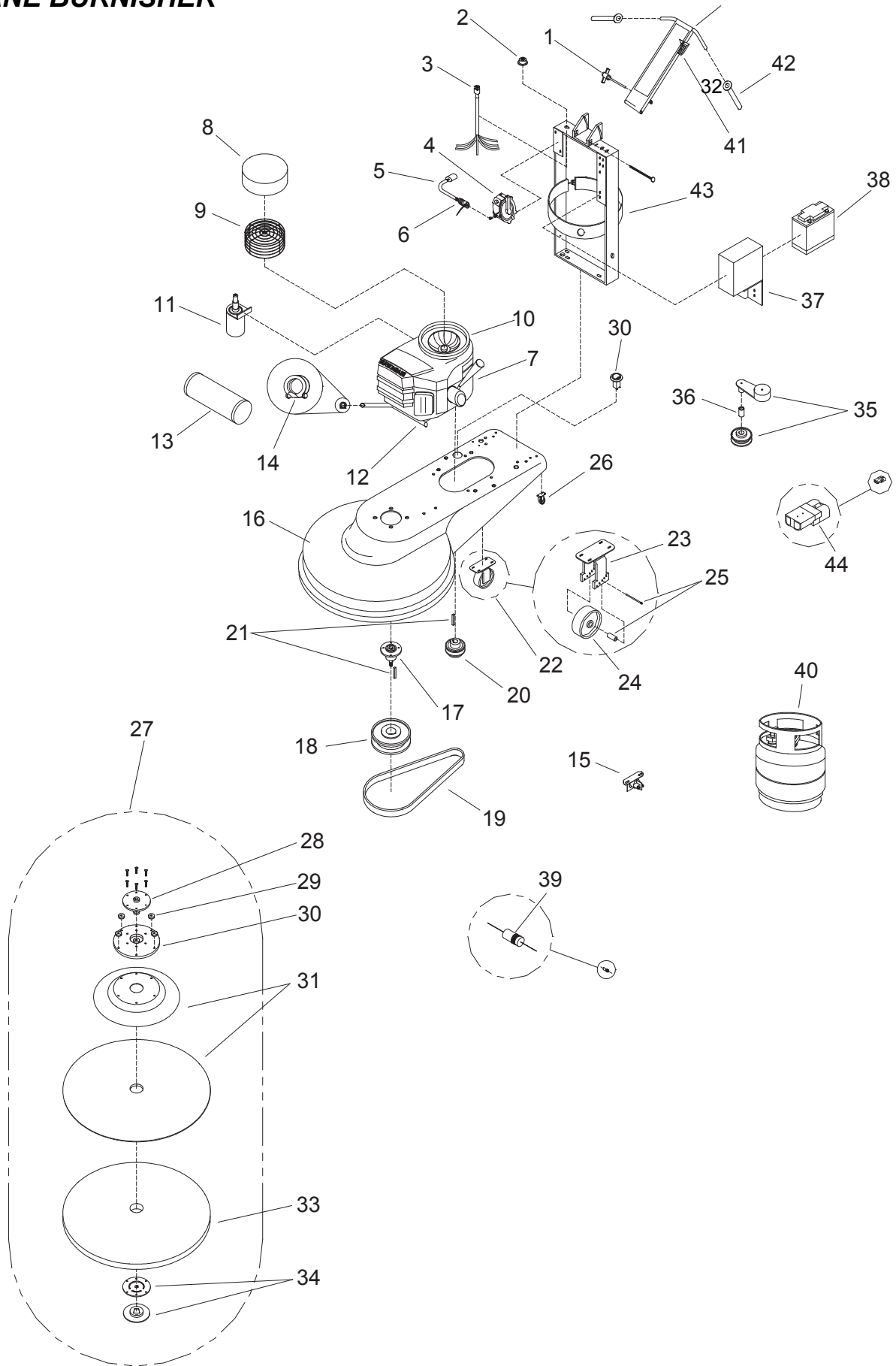

PROPANE BURNISHER

REF	PART NO.	PRV NO.	QTY	DESCRIPTION	SERIAL NO. FROM	NOTES:
1	88031640	W1454	1	HANDLE PIN		
2	86330190	W1301	1	IGNITION SWITCH		
3	86330200	W1302	1	IGNITION SWITCH HARNESS		
4	86330210	N-51-2A-3.0 (W2006)	1	REGULATOR		
5	86330220	W2649B	1	15" HOSE ASSEMBLY W/REGO		
6	86330230	W2608	1	ELECTRIC FUEL LOCK-OFF		
7	86344420	W3132A	1	18 HP KAWASAKI ENGINE ASSEMBLY		
8	86330250	W3305	1	BONNET FILTER		
9	86330260	W3311	1	BONNET CAGE		
10	86330270	W3306	1	BONNET SEAL		
11	86330280	K21163-7010	1	12 VOLT STARTER		
12	86330290	W3225	1	17 HP KAWASAKI MANIFOLD		
13	86330300	W3260	1	MUFFLER		
-	86330310	W3220	1	CATALYTIC CONVERTER		
14	86330320	K920427012	1	MUFFLER CLAMP		
15	86330330	W1305	1	SOLENOID 12V		
16A	86330340	W5024	1	24" DECK		
16B	86330350	W5027	1	27" DECK		
17	86330360	W1013	1	DRIVE ASSEMBLY		
18A	86330370	W2075	1	7.5" PULLEY (24")		
18B	86330380	W2085	1	8.8 PULLEY (27")		
19A	86330390	WB41	1	41" BELT (24")		
19B	86330400	WB51	1	51" BELT (27")		
20	86330410	W2035	1	3.5" PULLEY		
21	86330420	F47913	2	KEY STOCK		
22	86330430	W4210A	2	DELUXE WHEEL BRACKET ASSEMBLY		
23	86330440	W4210	2	DELUXE WHEEL BRACKET		
24	86330450	W4220	2	RUBBER WHEEL 6 X 1.5"		
25	86330460	W4221	2	AXLE KIT FOR W4220		
26	86330470	W4241	1	REAR CASTER		
27A	86330490	W1554A	1	24" PREMIUM PAD DRIVER		
27B	86330480	W1557A	1	27" PREMIUM PAD DRIVER		
28	86330500	W1078	1	5" FLANGE		
29	86330510	W1652	6	1.5 COUPLE SPACER		
30	86330520	W1650	1	10" COUPLER		
31A	86425500	W1554/W1550	1	GRIPPER SURFACE 24" W/RISER		
31B	86425430	W1557/W1550	1	GRIPPER SURFACE 27" W/RISER		
32	86330680	W4060	1	T-HANDLE		
33A	86330560	ON246	1	24" IMAGE BEIGE PAD		
33B	86330570	ON276	1	27" IMAGE BEIGE PAD		
34	86330580	W1501	2	PAD DRIVER CENTER-LOK 3"		
35	86330590	W1102A	1	FENNER ROTARY TENSIONER		
36	86330600	SF13RS050090	1	SPACER		
37	86330610	W4272	1	BATTERY BOX		
38	86330620	W4359	1	BATTERY 12V (PTX-14BS)		
39	86330700	W1306	1	6.0 AMP 400 VOLT DIODE		
40	86330640	W2502	1	PROPANE TANK 80% STEEL		
41	86330650	W4110	1	THROTTLE CABLE 53"		
42	86330660	W4050	2	HAND GRIP		
43	86330670	W4058	1	BOTTLE CARRIER		
44	86330690	W4363	1	BATTERY CONNECTOR		
-	86330630	W4302	1	HOUR METER	OPTIONAL	NOT SHOWN
-	86331350	W1210B	1	E-STOP SWITCH ASSEMBLY	OPTIONAL	NOT SHOWN
-	86331430	W1210	1	ELECTRIC CLUTCH	OPTIONAL	NOT SHOWN
-	86335660	W2808	1	EMISSION CONTROL AUTO SHUT DOWN	OPTIONAL	NOT SHOWN
-	86336730	W5124	1	SKIRT, 24" DUST CONTROL	OPTIONAL	NOT SHOWN
-	86336740	W5127	1	SKIRT, 27" DUST CONTROL	OPTIONAL	NOT SHOWN

NOTES: