

OPERATOR'S MANUAL

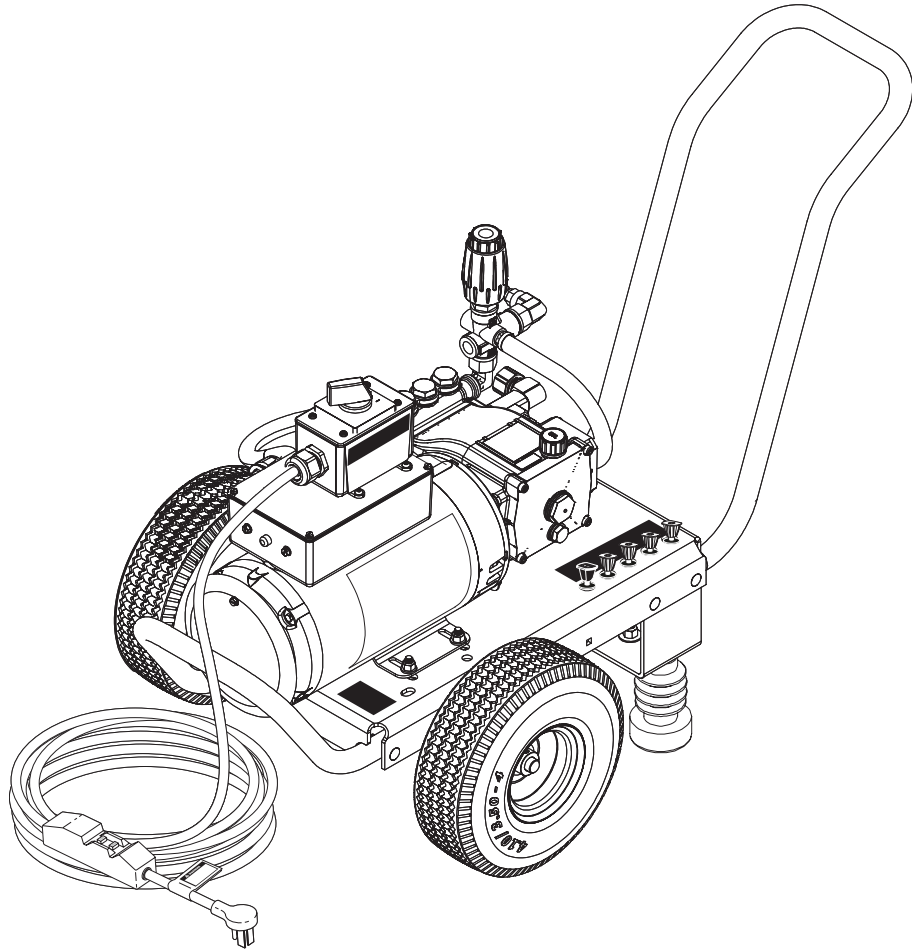

<u>MODEL #</u>	<u>ORDER #</u>
HD 2.0/1000 Ed	1.106-124.0
HD 1.9/1300 Ed	1.106-125.0
HD 3.0/1000 Ea	1.106-126.0
HD 3.5/2000 Ea	1.106-127.0
HD 1.8/1300 Ed	1.106-128.0

KNA, Inc. 4555 Airport Way Denver, CO 80239

9.801-810.0

Important Safety Information	4-5
Component Identification	6
Assembly Instructions.....	7
Operating Instructions.....	8
Detergent and General Operating Techniques	9
Shut Down and Clean-Up	10
Storage	10
Troubleshooting	11
Preventive Maintenance	12
Accessories and Parts list	13-15
Oil Change Record	16

Model Number _____

Serial Number _____

Date of Purchase _____

The model and serial numbers will be found on a decal attached to the pressure washer. You should record both serial number and date of purchase and keep in a safe place for future reference.

INTRODUCTION & IMPORTANT SAFETY INFORMATION

Thank you for purchasing this Pressure Washer.

We reserve the right to make changes at any time without incurring any obligation.

Owner/User Responsibility:

The owner and/or user must have an understanding of the manufacturer's operating instructions and warnings before using this pressure washer. Warning information should be emphasized and understood. If the operator is not fluent in English, the manufacturer's instructions and warnings shall be read to and discussed with the operator in the operator's native language by the purchaser/owner, making sure that the operator comprehends its contents.

Owner and/or user must study and maintain for future reference the manufacturers' instructions.

The operator must know how to stop the machine quickly and understand the operation of all controls. Never permit anyone to operate the engine without proper instructions.

SAVE THESE INSTRUCTIONS

This manual should be considered a permanent part of the machine and should remain with it if machine is resold.

When ordering parts, please specify model and serial number. Use only identical replacement parts.

This machine is to be used only by trained operators.

IMPORTANT SAFETY INFORMATION

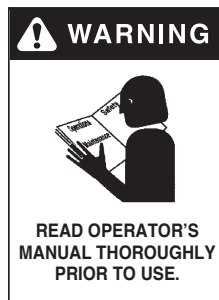

WARNING: To reduce the risk of injury, read operating instructions carefully before using.

1. Read the owner's manual thoroughly. Failure to follow instructions could cause malfunction of the machine and result in death, serious bodily injury and/or property damage.
2. Know how to stop the machine and bleed pressure quickly. Be thoroughly familiar with the controls.
3. Stay alert — watch what you are doing.
4. All installations must comply with local codes. Contact your electrician, plumber, utility company or the selling distributor for specific details. If your machine is rated 250 volts or less, single phase will be provided with a ground fault circuit interrupter (GFCI). If rated more than 250 volts, or more than single phase this product should only be connected to a power supply receptacle protected by a GFCI.

DANGER: Improper connection of the equipment-grounding conductor can result in a risk of electrocution. Check with a qualified electrician or service personnel if you are in doubt as to whether the outlet is properly grounded. Do not modify the plug provided with the product - if it will not fit the outlet, have a proper outlet installed by a qualified electrician. Do not use any type of adaptor with this product



WARNING: Keep wand, hose, and water spray away from electric wiring or fatal electric shock may result.

5. To protect the operator from electrical shock, the machine must be electrically grounded. It is the responsibility of the owner to connect this machine

to a UL grounded receptacle of proper voltage and amperage ratings. Do not spray water on or near electrical components. Do not touch machine with wet hands or while standing in water. Always disconnect power before servicing.



WARNING: Flammable liquids can create fumes which can ignite, causing property damage or severe injury.

WARNING: Risk of explosion — Do not spray flammable liquids.

6. Do not allow acids, caustic or abrasive fluids to pass through the pump.
7. Never run pump dry or leave spray gun closed longer than 1-2 minutes.
8. Keep operating area clear of all persons.



WARNING: High pressure spray can cause paint chips or other particles to become airborne and fly at high speeds. To avoid personal injury, eye, hand and foot safety devices must be worn.

9. Eye, hand, and foot protection must be worn when using this equipment.

IMPORTANT SAFETY INFORMATION

! WARNING



TRIGGER GUN KICKS BACK - HOLD WITH BOTH HANDS

WARNING: Grip cleaning wand securely with both hands before starting. Failure to do this could result in injury from a whipping wand.

14. Inlet water must be clean fresh water and no hotter than 90°F.
15. Manufacturer will not be liable for any changes made to our standard machines or any components not purchased from us.
16. The best insurance against an accident is precaution and knowledge of the machine.

! WARNING



RISK OF INJECTION OR SEVERE INJURY TO PERSONS. KEEP CLEAR OF NOZZLE.

WARNING: High pressure developed by these machines will cause personal injury or equipment damage. Keep clear of nozzle. Use caution when operating. Do not direct discharge stream at people, or severe injury or death will result.

! WARNING



RISK OF INJURY FROM FALLS WHEN USING LADDER.

WARNING: Be extremely careful when using a ladder, scaffolding or any other relatively unstable location. The cleaning area should have adequate slopes and drainage to reduce the possibility of a fall due to slippery surfaces.

10. To reduce the risk of injury, close supervision is necessary when a machine is used near children. Do not allow children to operate the pressure washer. **This machine must be attended during operation.**
11. Never make adjustments on machine while in operation.
12. Be certain all quick coupler fittings are secured before using pressure washer.

17. Do not overreach or stand on unstable support. Keep good footing and balance at all times.
18. Do not operate this machine when fatigued or under the influence of alcohol, prescription medications, or drugs.

! WARNING



PROTECT FROM FREEZING

WARNING: Protect machine from freezing.

13. To keep machine in best operating conditions, it is important you protect machine from freezing. Failure to protect machine from freezing could cause malfunction of the machine and result in death,

serious bodily injury, and/or property damage. Follow storage instructions specified in this manual.

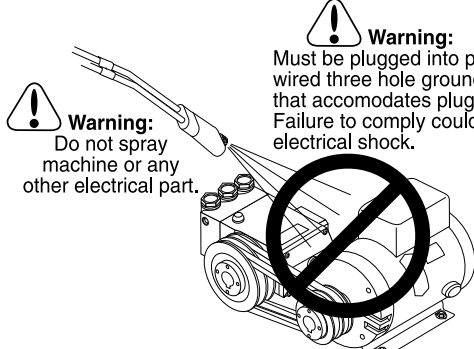

! Warning: Must be plugged into properly wired three hole grounded outlet that accommodates plug on power cord. Failure to comply could result in electrical shock.

! Warning: Do not spray machine or any other electrical part.



19. Follow the maintenance instructions specified in the manual.

COMPONENT IDENTIFICATION

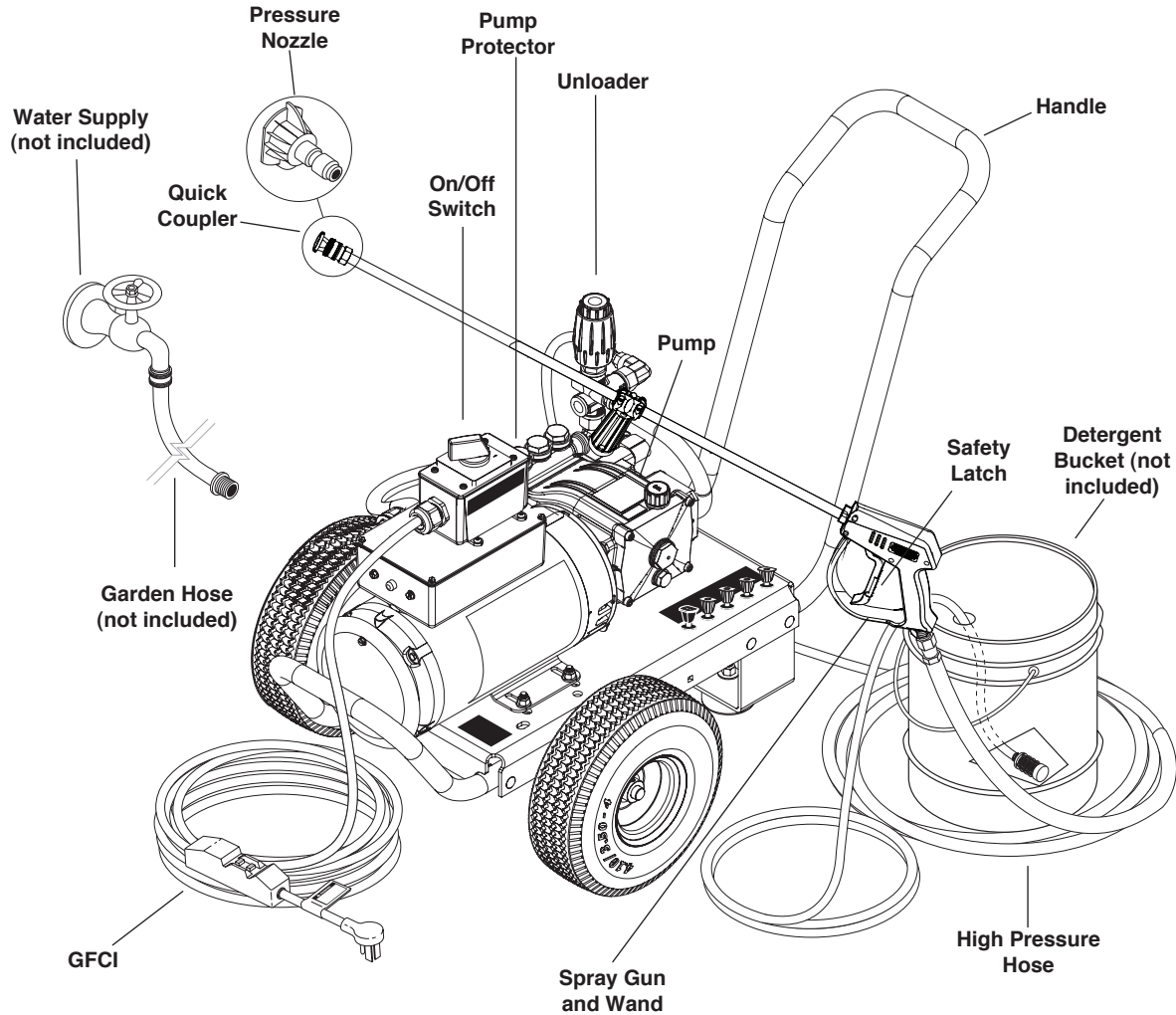

Pump — Develops high pressure.

Spray Gun — Controls the application of water and detergent onto cleaning surface with trigger device. Includes safety latch.

Wand — Must be connected to the spray gun.

Unloader — Safety device that relieves pressure when spray gun trigger is closed.

High Pressure Hose — Connect one end to water pump discharge nipple and the other end to spray gun.

Pump Protector — Cycles fresh cool water through pump when recirculating water reaches 140°F.

GFCI — Ground fault circuit interrupter trips when voltage leaks to ground.

Note: If trigger on spray gun is released for more than 1-2 minutes, water will leak from valve. Warm water will discharge from pump protector onto floor. This system prevents internal pump damage.

ASSEMBLY INSTRUCTIONS

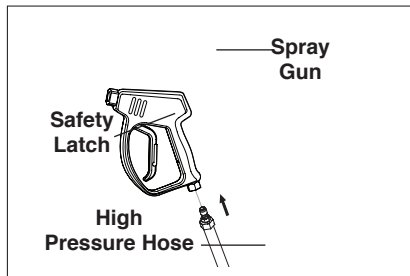

STEP 1: Attach the high pressure hose to the spray gun using teflon tape on hose threads.

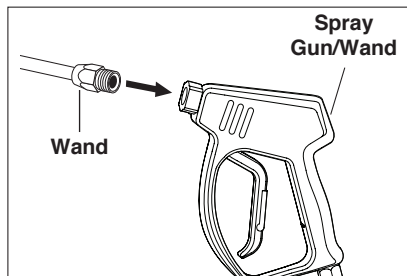

STEP 2: Attach wand to spray gun using teflon tape on wand threads.

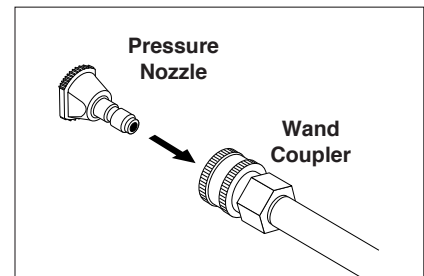

STEP 3: Pull spring-loaded collar of the wand coupler back to insert your choice of pressure nozzle.

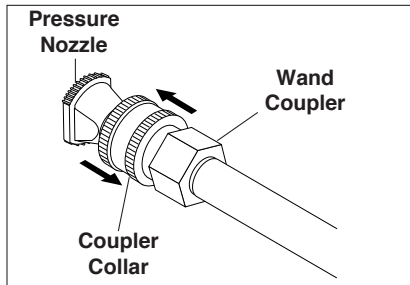

STEP 4: Release the coupler collar and push the nozzle until the collar clicks. Pull the nozzle to make sure it is seated properly.

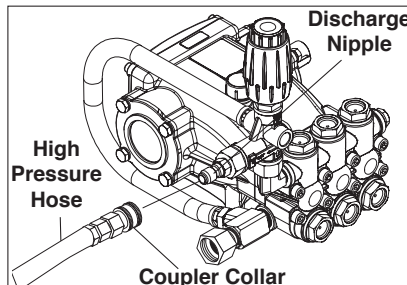

STEP 5: Connect the high pressure hose to the discharge nipple. Push coupler collar forward until secure.

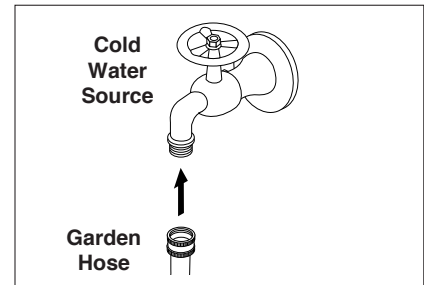

STEP 6: Connect garden hose to the cold water source.

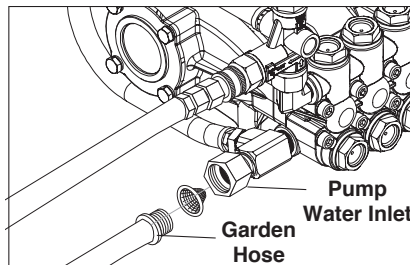

STEP 7: Check inlets filters, remove debris, then connect the garden hose to pump water inlet.

CAUTION: Do not run the pump without water or pump damage will result.

OPERATING INSTRUCTIONS

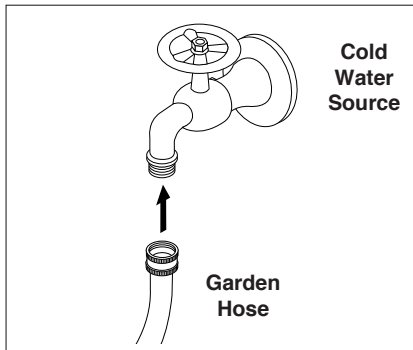

STEP 1: Connect garden hose to the cold water source and turn water on completely. Never use hot water.

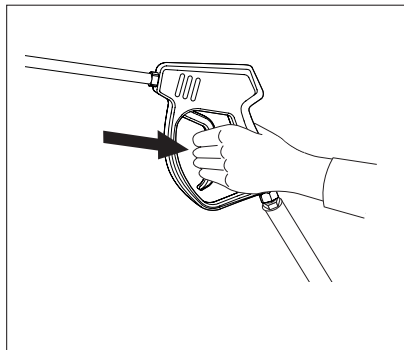

STEP 2: Trigger the spray gun to eliminate trapped air then wait for a steady flow of water to emerge from the spray nozzle.

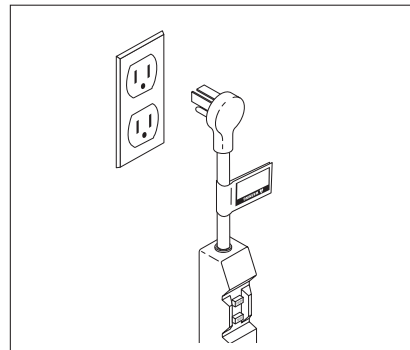

STEP 3: Connect to appropriate power supply. Push reset button on GFCI.

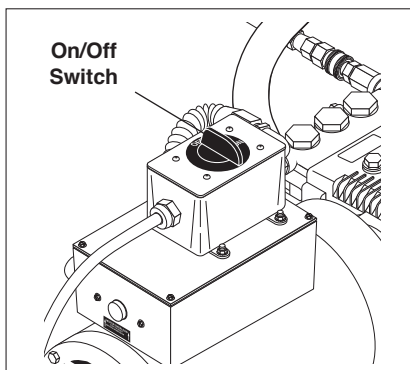

STEP 4: Turn machine on by turning switch at top of motor.

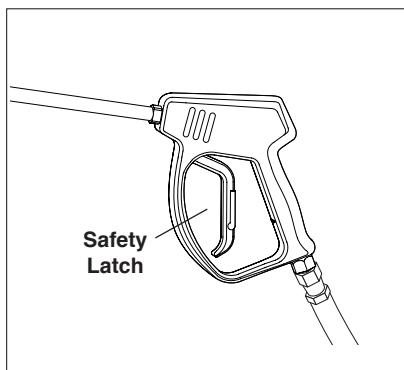

⚠ WARNING! Never replace nozzles without engaging the safety latch on the spray gun trigger.

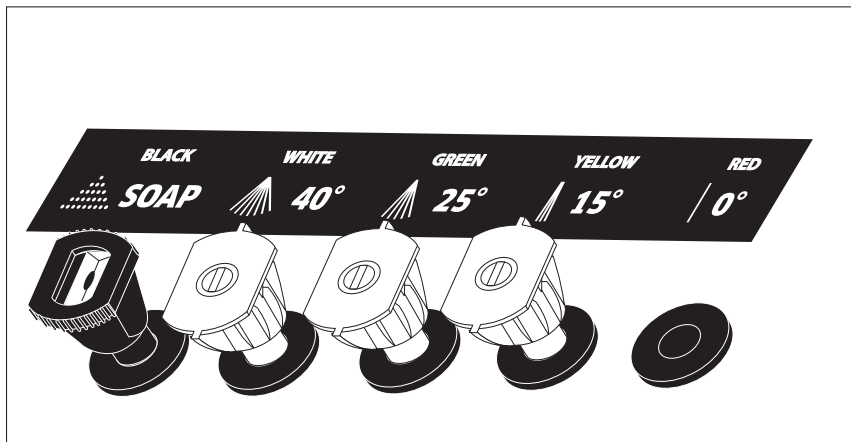

The four color-coded quick connect nozzles provide a wide array of spray widths from 15° to 40° and are easily accessible when placed in the convenient rubber nozzle holder, which is provided on the front of the machine.

NOTE: For a more gentle rinse, select the white 40° or green 25° nozzle. To scour the surface, select the yellow 15° nozzle. To apply detergent select the black nozzle.

DETERGENTS AND GENERAL OPERATING TECHNIQUES



WARNING: Some detergents may be harmful if inhaled or ingested, causing severe nausea, fainting or poisoning. The harmful elements may cause property damage or severe injury.

STEP 1: Connect detergent injector to discharge nipple on machine. Connect high pressure hose to injector with quick coupler. (Check to make sure locking coupler sleeves are in proper position before applying water pressure).

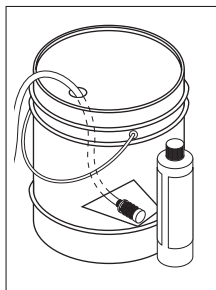
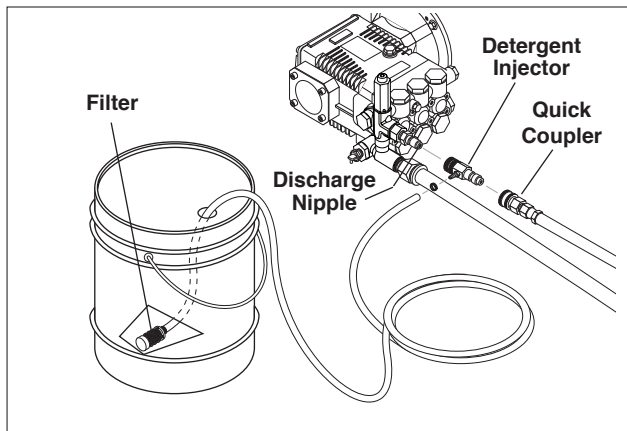

STEP 2: Use detergent designed specifically for pressure washers. Household detergents could damage the pump. Prepare detergent solution as required by the manufacturer. Fill a container with pressure washer detergent. Place the filter end of detergent suction tube into the detergent container.

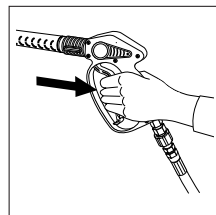

STEP 3: With safety latch on spray gun engaged, secure black detergent nozzle into quick coupler. **NOTE:** Detergent cannot be applied using a pressure nozzle.

STEP 4: With the motor running, pull trigger to operate machine.

Liquid detergent is drawn into the machine and mixed with water. Apply detergent to work area. Do not allow detergent to dry on surface.

IMPORTANT: You must flush the detergent injection system after each use by placing the suction tube into a bucket of clean water, then run the pressure washer in low pressure for 1-2 minutes.

THERMAL PUMP PROTECTION

If you run the motor on your pressure washer for 1-2 minutes without pressing the trigger on the spray gun, circulating water in the pump can reach high temperatures. When the water reaches this temperature, the pump protector engages and cools the pump by discharging the warm water onto the ground. This thermal device prevents internal damage to the pump.

CLEANING TIPS

Pre-rinse cleaning surface with fresh water. Place detergent suction tube directly into cleaning solution and apply to surface at low pressure (for best results, limit your work area to sections approximately 6 feet square and always apply detergent from bottom to top). Allow detergent to remain on surface 1-3 minutes. Do not allow detergent to dry on surface. If surface appears to be drying, simply wet down surface with fresh water. If needed, use brush to remove stubborn dirt. Rinse at high pressure from top to bottom in an even sweeping motion keeping the spray nozzle approximately 1 foot from cleaning surface. Use overlapping strokes as you clean and rinse any surface. For best surface cleaning action spray at a slight angle.

Recommendations:

- Before cleaning any surface, an inconspicuous area should be cleaned to test spray pattern and distance for maximum cleaning results.
- If painted surfaces are peeling or chipping, use extreme caution as pressure washer may remove the loose paint from the surface.
- Keep the spray nozzle a safe distance from the surface you plan to clean. High pressure wash a small area, then check the surface for damage. If no damage is found, continue to pressure washing.

! CAUTION - Never use:

- Bleach, chlorine products, other corrosive chemicals
- Liquids containing solvents (i.e., paint thinners, gasoline, oils)
- Tri-sodium phosphate products
- Ammonia products
- Acid-based products

These chemicals will harm the machine and will damage the surface being cleaned.

RINSING

It will take a few seconds for the detergent to clear. Apply safety latch to spray gun. Remove black soap nozzle from the quick coupler. Select and install the desired high pressure nozzle. **NOTE:** You can also stop detergent from flowing by simply removing detergent siphon tube from bottle.

SHUTTING DOWN AND CLEAN-UP

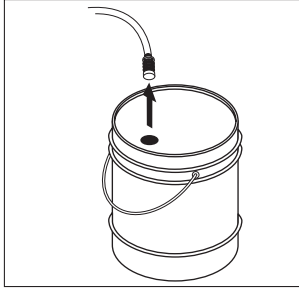

STEP 1: Remove detergent suction tube from container and insert into one gallon of fresh water. Slide nozzle forward for low pressure or use black detergent nozzle. Pull trigger on spray gun and siphon fresh clean water for one minute.

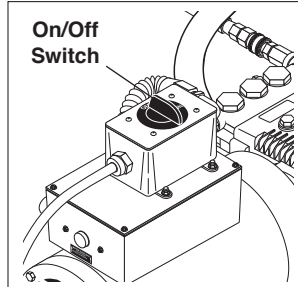

STEP 2: Turn off machine by turning switch to "OFF" switch.

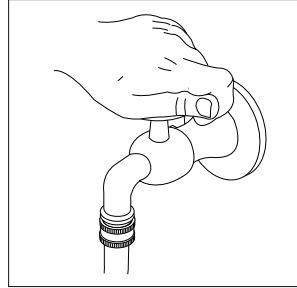

STEP 3: Turn off water supply.

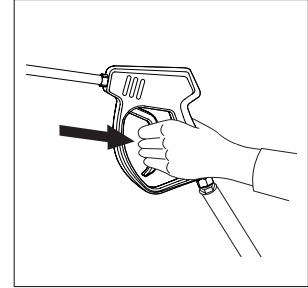

STEP 4: Press trigger to release water pressure.

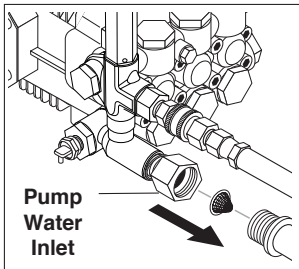

STEP 5: Disconnect the garden hose from the water inlet on the machine.

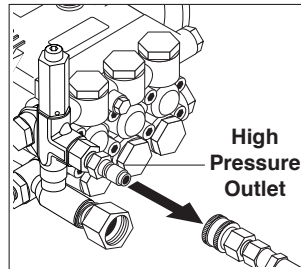

STEP 6: Disconnect the high pressure hose from the discharge nipple.

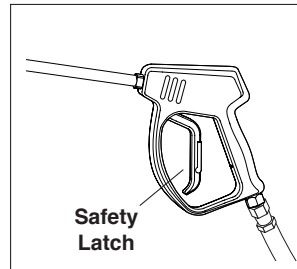

STEP 7: Engage the spray gun safety lock.

STORAGE

Pump Storage



CAUTION

CAUTION: Always store your pressure washer in a location where the temperature will not fall below 32°F (0°C). The pump in this machine is susceptible to permanent damage if frozen.

FREEZE DAMAGE IS NOT COVERED BY WARRANTY.

If you must store your pressure washer in a location where the temperature is below 32°F, you can minimize the chance of damage to your machine by draining your machine as follows:

1. Stop the pressure washer and detach supply hose and high pressure hose. Squeeze trigger of spray gun to drain all water from the wand and hose.
2. Restart pressure washer and let it run briefly (about 5 seconds) until water no longer discharges from the high pressure outlet.

TROUBLESHOOTING

PROBLEM	POSSIBLE CAUSE	SOLUTION
PUMP RUNNING NORMALLY BUT PRESSURE LOW ON INSTALLATION	Pump sucking air	Check water supply and possibility of air seepage.
	Check valves sticking	Check and clean or replace if necessary.
	Unloader valve seat faulty	Check and replace if necessary.
	Nozzle incorrectly sized	Check and replace if necessary.
	Worn piston packing	Check and replace if necessary.
FLUCTUATING PRESSURE	Valves worn	Check and replace if necessary.
	Blockage in valve	Check and replace if necessary.
	Pump sucking air	Check water supply connections.
	Worn piston packing	Check and replace if necessary.
	Insufficient water	Check filter and hose for breakage.
PRESSURE LOW AFTER PERIOD OF NORMAL USE	Nozzle worn	Check and replace if necessary.
	Suction or delivery valves worn	Check and replace if necessary.
	Suction or delivery lines blocked	Check and clean if necessary.
	Unloader valve seat worn	Check and replace if necessary.
	Worn piston packing	Check and replace if necessary.
	Water temperature excessive	Reduce to below 160° F.
PUMP NOISY	Air in suction line	Check water supply and connections on suction line.
	Broken or weak suction or delivery valve spring	Check and replace if necessary.
	Foreign matter in valves	Check and clean if necessary.
	Worn bearings	Check and replace if necessary.
	Excessive temperature of water	Reduce to below 160° F.
PRESENCE OF WATER IN PUMP OIL	Oil seal worn	Check and replace if necessary.
	High humidity in air	Check and replace if necessary.
	Piston packing worn	Check and replace if necessary.
WATER DRIPPING FROM UNDER PUMP	Piston packing worn	Check and replace if necessary.
	O-ring plunger retainer worn	Check and replace if necessary.
WATER DRIPPING FROM PUMP PROTECTOR	Water supply pressure too high (over 90 PSI)	Lower water supply pressure using a regulator.
	Spray gun is in the off position for over 5 minutes	Turn machine off if not in use for over 1-2 minutes.
OIL DRIPPING	Oil seal worn	Check and replace if necessary.
EXCESSIVE VIBRATION IN HIGH PRESSURE HOSE	Irregular functioning of the pump valves	Check and replace if necessary.
MOTOR DOES NOT START WHEN SWITCHED ON	Plug not well connected or lack of power supply	Check plug, cable and switch.
WHEN SWITCHING ON THE MACHINE, MOTOR HUMS BUT DOES NOT RUN	Main voltage is insufficient, lower than the minimum required	Check to make sure main power supply is adequate.
	The pump is stuck or frozen	Check by turning the motor manually.
MOTOR STOPS	Tripped thermal overload due to overheating	Check that main voltage corresponds to the specifications. Wait a few minutes before turning on the machine again by resetting the GFCI cord.

PREVENTATIVE MAINTENANCE

PREVENTATIVE MAINTENANCE

This pressure washer was produced with the best available materials and quality craftsmanship. However, you as the owner have certain responsibilities for the correct care of the equipment. Attention to regular preventative maintenance procedures will assist in preserving the performance of your equipment. Contact your dealer for maintenance. Regular preventative maintenance will add many hours to the life of your pressure washer. Perform maintenance more often under severe conditions.

MAINTENANCE SCHEDULE		
Pump Oil (Non foaming) SAE 10W-40	Inspect	Daily inspect the oil level
	Change	After first 50 hours, then every 500 hours or annually
Replace High Pressure Nozzle		Every 6 months
Replace Quick Connects		Annually
Clean Water Screen/Filter		Weekly
Replace HP Hose		Annually if there is any sign of wear
Grease Motor		Every 10,000 hours

OIL CHANGE RECORD

Check pump oil and engine oil level before first use of your new pressure washer.

Date Oil Changed Month/Day/Year	Estimated Operating Hours Since Last Oil Change	Date Oil Changed Month/Day/Year	Estimated Operating Hours Since Last Oil Change

ACCESSORIES ASSEMBLY

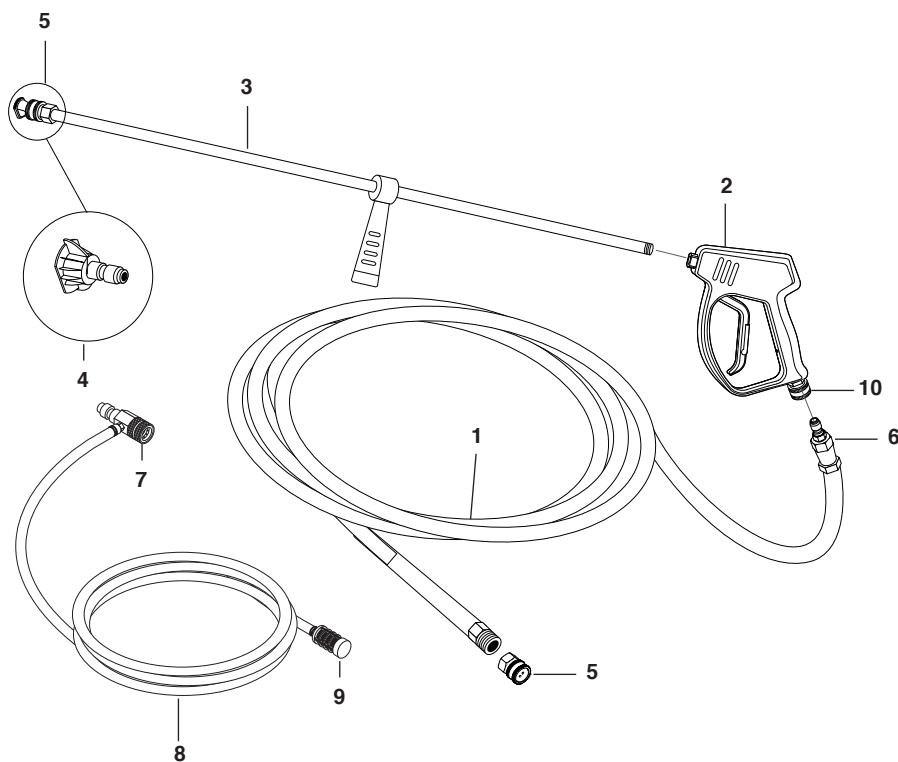

ACCESSORIES ASSEMBLY PARTS LIST

ITEM	PART NO.	DESCRIPTION	QTY
1	8.925-129.0	HOSE, 3/8" X 50' 1W 4000PSI SW X SO	1
2	8.750-247.0	Gun, M407	1
3	8.783-039.0	Wand 30" Zinc Plated, Handle & Coupler	1
4	Quick Connect Nozzle Kit (3.5) (HD 2.0/1000 Ed)		
	8.712-338.0	▲ Nozzle, SAQCMEG 1503.5, Yellow	1
	8.712-339.0	▲ Nozzle, SAQCMEG, 2503.5, Green	1
	8.712-340.0	▲ Nozzle, SAQCMEG 4003.5, White	1
	8.712-398.0	▲ Nozzle Compl, Qcem-6540 Brass (chem)	1
	Quick Connect Nozzle Kit (3.25) (HD 1.9/1300 Ed)		
	8.712-338.0	▲ Nozzle, SAQCMEG, 1503.25, Yellow	1
	8.712-339.0	▲ Nozzle, SAQCMEG, 2503.25, Green	1
	8.712-340.0	▲ Nozzle, SAQCMEG, 4003.25, White	1
	8.712-398.0	▲ Nozzle Compl, Qcem-6540 Brass (chem)	1
	Quick Connect Nozzle Kit (5.5) (HD 3.0/1000 Ea)		
	8.712-358.0	▲ Nozzle, SAQCMEG 1505.5, Yellow	1
	8.712-359.0	▲ Nozzle, SAQCMEG 2505.5, Green	1
	8.712-360.0	▲ Nozzle, SAQCMEG 4005.5, White	1
	8.712-398.0	▲ Nozzle Compl, Qcem-6540 Brass (chem)	1
	Quick Connect Nozzle Kit (5.0) (HD 3.5/2000 Ea)		
	8.712-354.0	▲ Nozzle, SAQCMEG 1505, Yellow	1
	8.712-355.0	▲ Nozzle, SAQCMEG 2505, Green	1
	8.712-356.0	▲ Nozzle, SAQCMEG 4005, White	1
	8.712-398.0	▲ Nozzle Compl, Qcem-6540 Brass (chem)	1
	Quick Connect Nozzle Kit (3.0) (HD 1.8/1300 Ed)		
	8.712-333.0	▲ Nozzle, SAQCMEG 1503, Yellow	1
	8.712-334.0	▲ Nozzle, SAQCMEG 2503, Green	1
	8.712-335.0	▲ Nozzle, SAQCMEG 4003, White	1
	8.712-398.0	▲ Nozzle Compl, Qcem-6540 Brass (chem)	1

ACCESSORIES ASSEMBLY PARTS LIST

ITEM	PART NO.	DESCRIPTION	QTY
5	9.802-166.0	Coupler, 3/8" Female, Brass	1
6	9.802-170.0	Coupler 3/8" PLUG, FEMALE, STEEL/ZINC	1
7	9.802-216.0	Injector, Chem, 0.083	1
8	6.388-216.0	Hose DN 5	1
9	5.731-652.0	Filter with weight	1
10	9.802-169.0	Coupler, 3/8" Socket, Male, Brass	1

▲ Not Shown

OIL CHANGE RECORD

Check pump oil and engine oil level before first use of your new pressure washer.

Date Oil Changed Month/Day/Year	Estimated Operating Hours Since Last Oil Change

Date Oil Changed Month/Day/Year	Estimated Operating Hours Since Last Oil Change

KNA, Inc. 4555 Airport Way Denver, CO 80239

Form #9.801-810.0 • Revised 04/20 • Printed in U.S.A. or Mexico