

Welcome to the Product guide

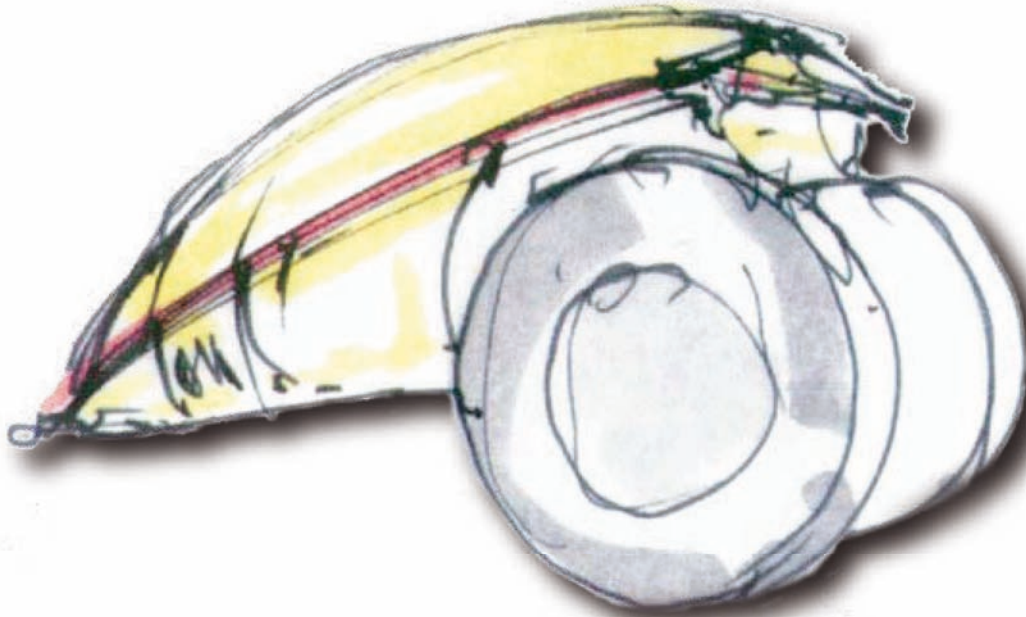

First impressions of a new product are a little like the first sighting of an iceberg on the ocean. While 90% of the iceberg is below the surface it is only the visible portion that forms the initial impression of its substance.

A great deal of design work and testing has taken place before the introduction of the new HARDI COMMANDER trailer. The new COMMANDER represents HARDI's greatest ever investment in product development.

More than 6 patents are currently pending in relation to the development of the COMMANDER.

Furthermore, comprehensive service and production technical documentation has been developed before the first new COMMANDER is delivered to customers in Europe, Australia or North America.

This Product Guide provides a marketing tool that concentrates more on technical argumentation than normal brochure material.

This Product Guide, used in conjunction with the COMMANDER interactive CD-ROM provides an excellent marketing tool to aid in what we trust will be the highly successful introduction of HARDI's latest foray into the trailed spraying marketplace.

Read on and enjoy

Confidential

This is your personal sample of the New COMMANDER Product guide and should be used as your personal sales tool - please treat it confidentially.

Date: _____

Signature: _____



Product guide

CONTENTS

Concept

Design criteria	4
Features	5
Functional design	6
Work zone	7

Chassis

Surface treatment	8
Frame	9
Drawbar	10
Service area	11
SafeTrack	12
SafeTrack stability	13
SafeTrack turning	14
Suspension	15
ParaLift	16
Main tank	17
RinseTank	18
Clean Water Tank	19

Fluid system

Overview - standard	20
SmartValve	21
Pump	22
Pressure control	23
EasyClean filter	24
EasyClean filter	25
CycloneFilter	26
CycloneFilter	27
ChemFiller	28
EFC boom section valves	29
LookAhead pressure regulation	30

Electronics

Control box units	31
Control box units	32
HC 5500 Controller	33

Booms

Boom survey	34
Boom survey	35
Suspension	36
Hydraulic	37
Boom wings	38
TWIN FORCE boom sections	39
FORCE boom sections	40
EAGLE boom sections	41
TWIN	42
TWIN	43

Options

ChemLocker	44
Night spraying lights	44
External Cleaning Kit	45
Foam marker	46
Nozzles	47

Specification

Dimensions	48
----------------------	----



Design criteria



Farming practises are constantly changing. Farmers are met with a daily challenge to improve capacity and reduce operating cost.

To help you meet this challenge HARDI has developed the next generation of trailed sprayers.

The new COMMANDER is designed to meet the demands of the modern professional farmer worldwide. This new generation of sprayers is designed to lead the way in capacity, reliability and ease of operation.

The new COMMANDER is a high-end performer designed for continuous use by demanding operators.

Features

Concept

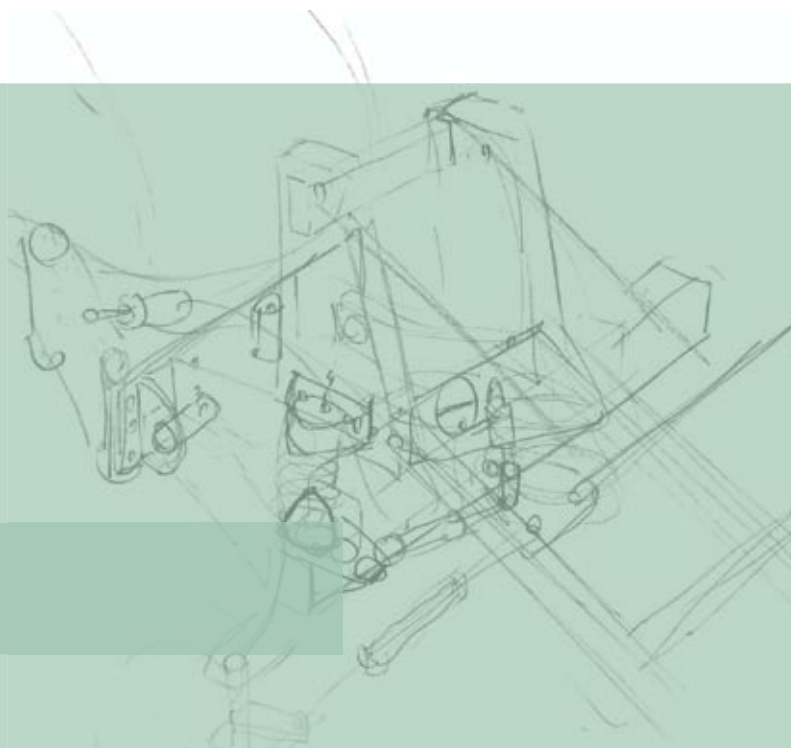

Features

An example of the functional design is the logical layout of the left hand side of the sprayer, where all primary operations are located – no need to open side panels to operate the sprayer.

Take a closer look at some of the other features making the New COMMANDER the best choice on the market for trailed sprayers.

High capacity

- The patent pending new *EasyClean* suction filter and *CycloneFilter* are ensuring large filtering capacity. The standard 3" main tank quick fill and 2" rinse tank quick fill allow for less down time between fills.

The *ChemFiller* gives 3 times more capacity due to the vortex action, where the liquid is rotating for easy mixing.

Wide boom range – *EAGLE*, *FORCE* and *TWIN FORCE* booms from 80 to 132 feet, all with HARDI® patented boom suspension system.

Easy to use

- With the logical *SmartValve* arrangement, you control the primary spray functions with only two handles.

With the new HARDI® 5500 controller and *LookAhead* feature, you have the best possibilities to control the application and boom operation with color coded controls.

Precision

- The *LookAhead* system gives a very fast pressure regulation during changes in speed. It remembers the settings according to different operation situations and gives an accurate application rate.

High stability performance and minimum of boom movements is the characteristics for the boom program. The *TWIN FORCE* concept has a proven better precision of application under difficult conditions.

Safety

- The patent pending *SafeTrack* concept is one of the most revolutionary innovations at the new COMMANDER giving you a dynamic stability control and a narrow turning radius.

In the design process, safety has been a high focus issue developing the working zone e.g. *ChemFiller* induction bowl and the *EasyClean* suction filter, where the automatic shut off valve eliminates spill.

Functional design



A good design will by definition result in a product with strong functionality.

So when developing the design of our new generation of sprayers, improving the functionality of the product was top priority.

Work zone



An example of functional design is the work zone where all primary functions are placed in an easy to reach position.

Everything you need to operate the sprayer is available in this area and everything is designed to be simple and logical to understand and operate.

The large safety locker is placed right over the work zone along with the clean water tank.

- ① **SmartValve - suction**
- ② **SmartValve - pressure**
- ③ **EasyClean filter**
- ④ **Agitation valve**
- ⑤ **Filling valves**

Surface treatment



Material:
UV protected

14 steps of cleaning, degreasing and preparation

Hardening at 392° F for one hour

Will last at least 1000 hours in salt fog test, without any corrosion

The chassis and all other steel components have been pre-treated with zinc phosphate before the application of a high quality coating of powder paint.

This treatment provides outstanding protection against corrosion from both chemicals and harsh weather conditions.



Frame

Chassis



Heavy duty chassis manufactured with high strength steel

The COMMANDER chassis is built with high strength steel ensuring exceptional strength, at a relatively low weight. The chassis is built to endure under the most difficult conditions anywhere in the world.

The chassis is constructed with a low center of gravity

A sprayer with a high center of gravity can be very dangerous to operate. A large effort has therefore been done to ensure that the COMMANDER has the lowest possible center of gravity without compromising clearance under the sprayer.

Excellent clearance

The unique design of the axle and frame ensures excellent crop clearance. No steering components are lower than the axle.

The drawbar on the tractor and the axle on the sprayer will therefore always be the lowest points on the sprayer. The clearance under the axle will vary between 27 - 31" depending on the tire and wheel set-up.

Domex steel

Laser cut tubing

CNC bending



Drawbar



On 6600
Suspended drawbar ensures comfortable operation under even high spraying and transport speed.

Drawbar bushing can be fitted to standard 50mm hole or reduced to 33 mm

The PTO shaft support bracket is standard on all machines.

Jack stand is easily removed or stored.

The drawbar on COMMANDER 6600 is as standard fully suspended.

The full up and down load from the sprayer to the tractor and transferred through rubber dampers built into the chassis.

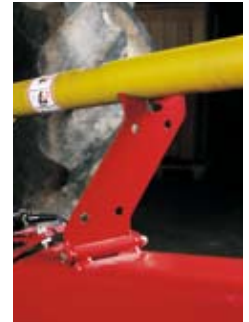

The drawbar on COMMANDER 6600 furthermore has a hydraulic support leg as standard.

The hydraulic support leg is driven by a separate hydraulic outlet on the tractor and ensures easy and safe attachment of the sprayer.

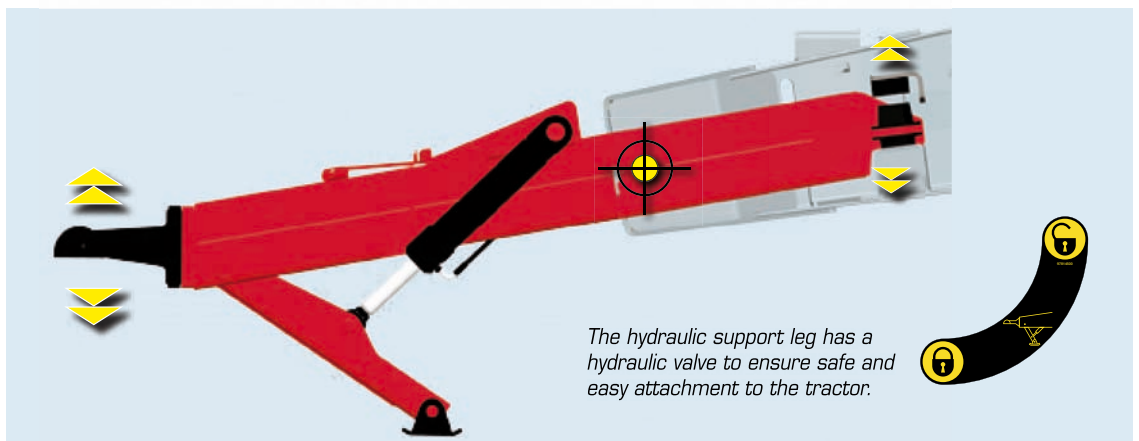

The hydraulic support leg has a hydraulic valve to ensure safe and easy attachment to the tractor.

Service area

Chassis



Easy tank inspection of the tank

The lid is located in close proximity to the platform to allow for easy inspection of the tank. The design of the tank allows the operator excellent visibility of both the sides and bottom of the tank.

Fold down ladder for easy access

The fold down ladder simply pulls down for easy access to the platform.

Relatively low platform placement

The platform is placed as low as possible enabling easy access.

Access to electronic system through rear panel

To aid in service accessibility the majority of electronic components and connections are located in a box behind the rear panel of the platform.

Easy access to fluid system

In order to provide excellent service access to the fluid system can be gained through the floor plate of the platform.

Protected placement of gauges

Gauges for monitoring the condition of the suction filter and the pressure gauge are mounted over the platform. This provides excellent visibility from the tractor and good protection from the elements.

Height over ground:
52"

Width 24"
Depth 28"

Height from floor
to lid:
4400 52"
6600 55"

SafeTrack



Turning radius
4400 is 20 ft
6600 is 29 ft

The new HARDI SafeTrack is available as an option on the new COMMANDER. This revolutionary design merges the benefits from other traditional systems into one high performance steering system. With the HARDI SafeTrack you do not have to choose between a tighter turning radius or better stability.

Narrow track width

With the safe track, wheel track widths down to 60" with a 320/90 R 50 tire is possible. This can be done without compromising the turning radius.

No pivot point between pump and manifold

The pivot point of the steering system has been moved away from the pump and other critical fluid components, ensuring that wear on hoses are reduced.

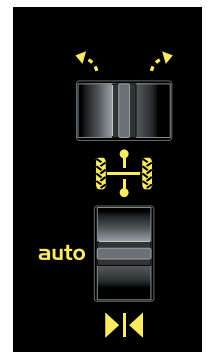

Operated from
Hydraulic box

SafeTrack stability

Exceptional driving stability

The unique design of the SafeTrack makes this system very stable. The center of gravity on the Safe Track is further back from the "stability line" than what is found on a traditional drawbar steering system. Because of the unique geometry the boom will act as a counter weight, moving the center of gravity away from the stability line. Making the system even more stable.

Dynamic Electronic Control (DEC)

Steering radius is determined by track width and forward speed

ensuring an even higher degree of stability. Fast turns will result in reduced tracking angles but maintain the safety of the operation.

Furthermore, if the HARDI electronic tank contents indicator is present, DEC will also actively compute this to determine the safest tracking angle.

Sharper turns are possible with a nearly empty tank as the center of gravity is lower compared to a full tank.

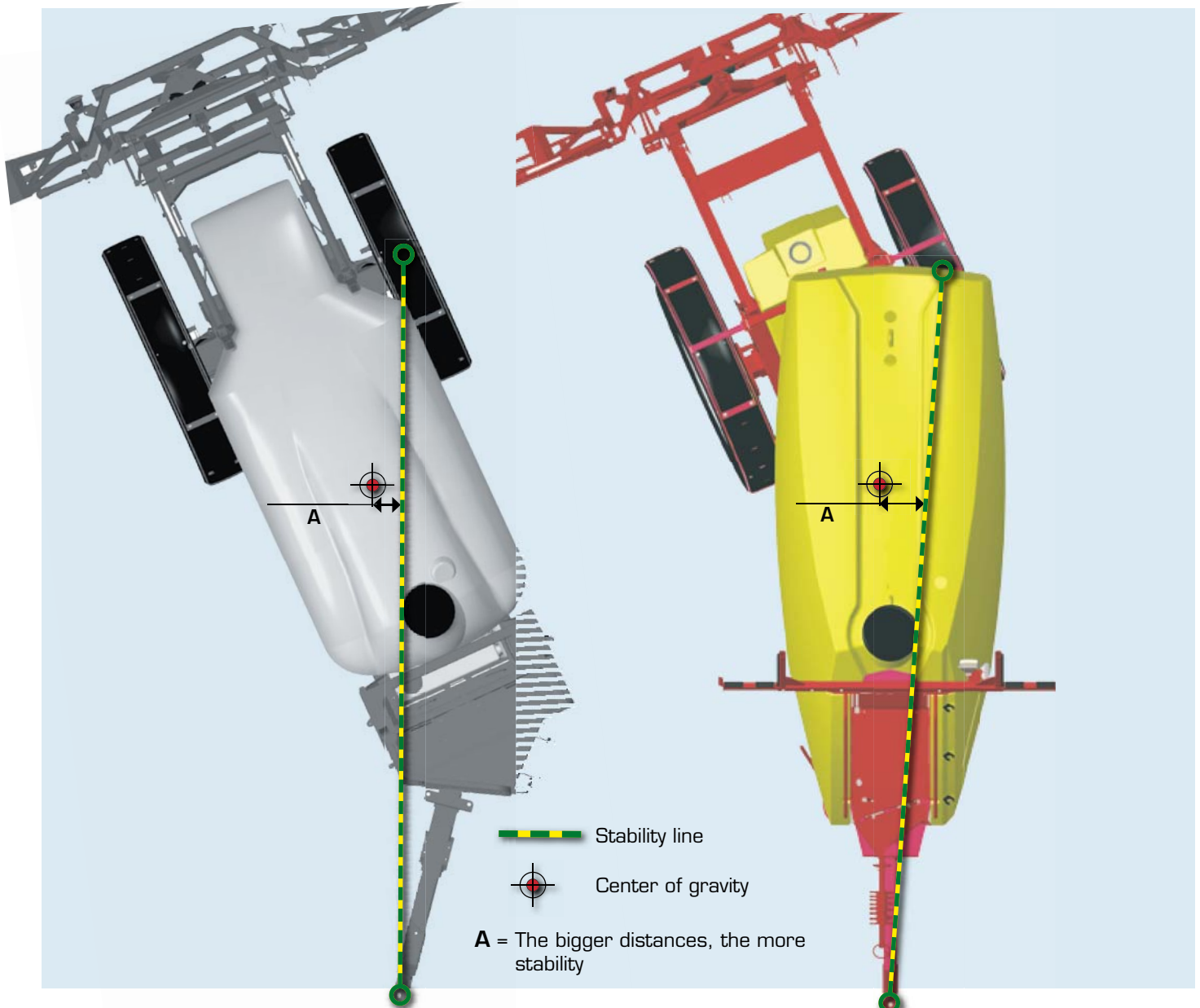

SafeTrack turning

Turning radius down to 20 ft

The SafeTrack has a very narrow turning radius that outperforms all other wheel steering concepts.

Boom always perpendicular to the row

Since the wheels are always parallel to the rows or tramlines, the boom will always be perpendicular to the spraying direction, even when turning at the end of a row. This ensures optimal application.

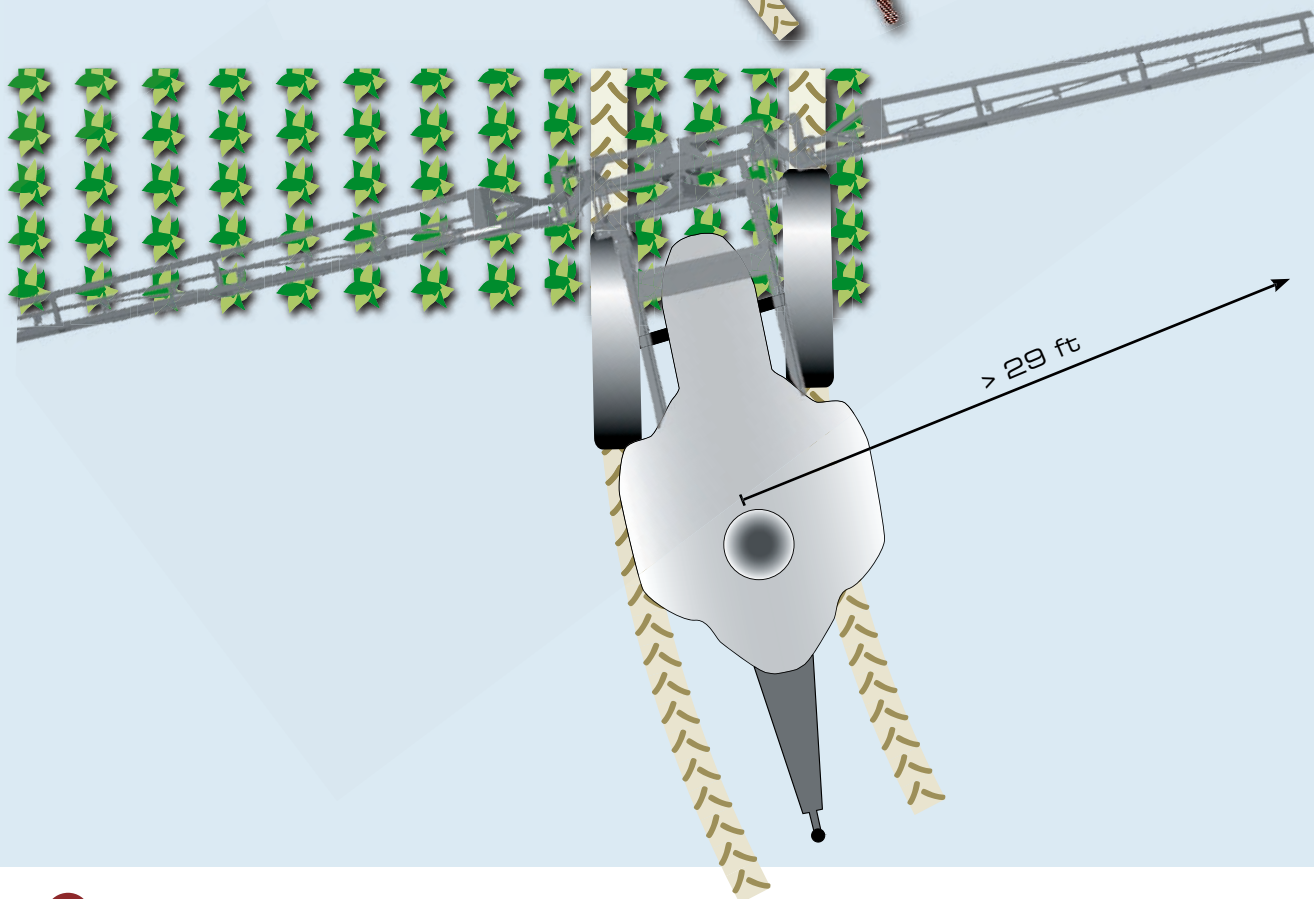
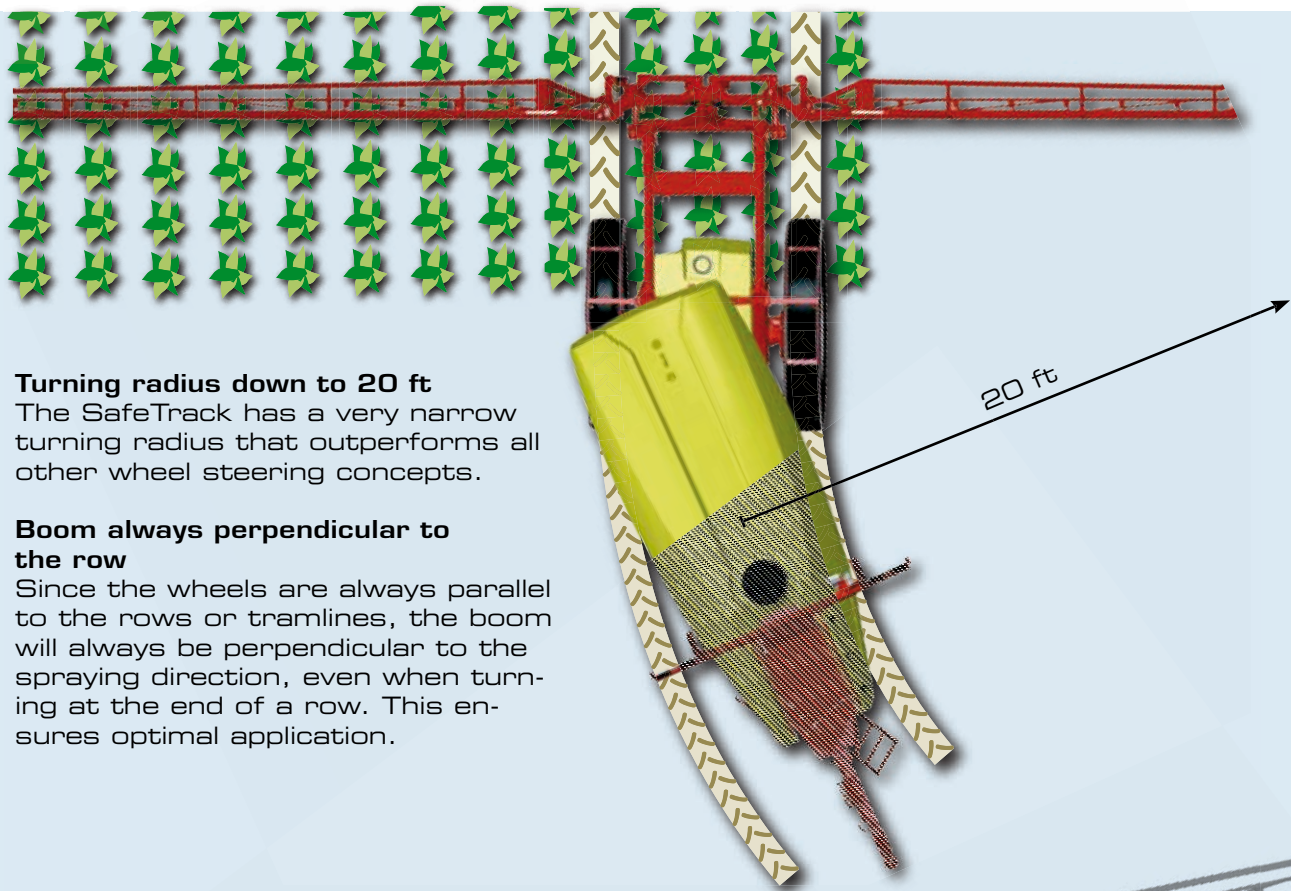

Suspension



Strong hydraulic cylinders absorb the shock loads instead of transferring them to the boom and tractor

This ensures operator comfort and good application at even higher speeds.

Compact suspension system permits track width down to 60", with 320/90 R 50 tires

High comfort level at high driving and spraying speeds

Suspension is adjusted to match tank and boom size from the factory

Suspension does not compromise the clearance

Progressive suspension travel of 4-5"

Suspension range 4,400-17,640 lbs

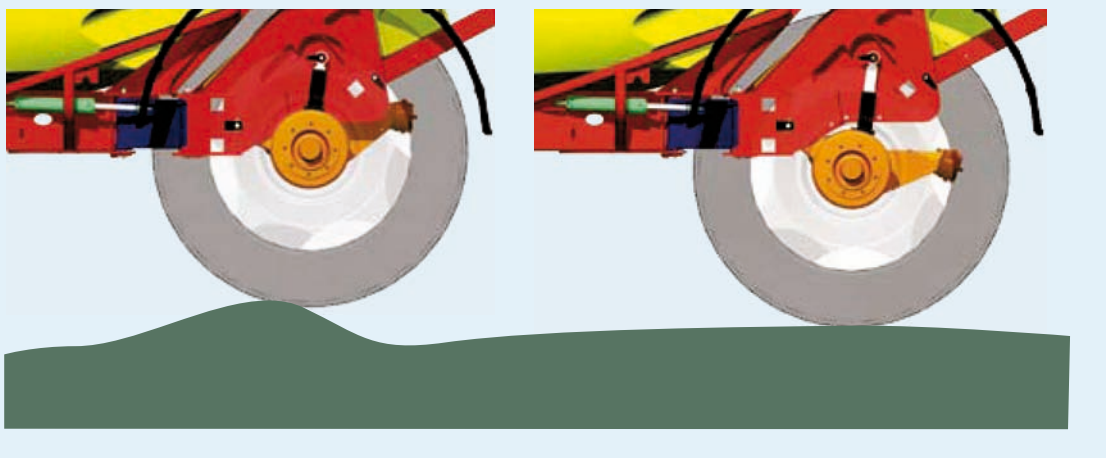

ParaLift



Flexible height adjustment

Down to 16"
Up to 88"

ParaLift width: 40"

Easy service

The HARDI ParaLift requires minimum of service (lubrication, adjustment etc.) compared to traditional H frame systems.

The HARDI ParaLift ensures high clearance above any crops

The long lift arms allow for very flexible height adjustment, the boom can be adjusted from 16" to 88", depending on sprayer wheel combination.

Wide attachment to the boom suspension ensures high performance of the boom

The 40" wide ParaLift ensures very stable attachment of the boom.

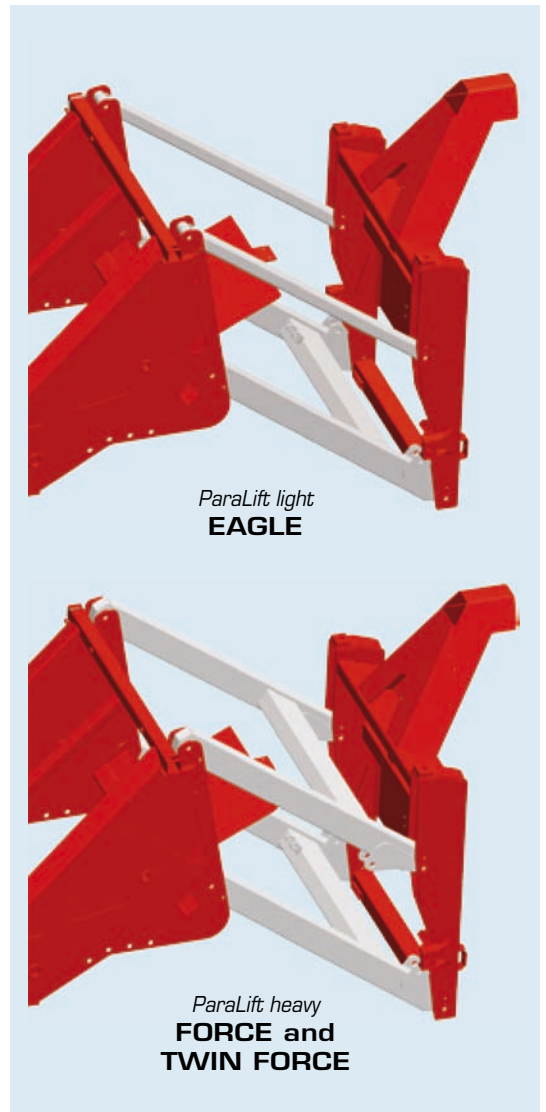

Main tank



Tanks available:
Model 4400 is 1200 gallons
Model 6600 is 1850 gallons

Very low center of gravity

To make the sprayer as stable as possible the tank is much wider at the bottom. This ensures a low center of gravity.

Liquid is moved forward as the tank is emptied, thereby maintaining weight on the drawbar

This ensures that traction on the tractor is maintained, even when

going up slopes with an almost empty tank.

Efficient agitation

Because of the forward sloping of the tank, agitation towards the sump is very effective.

Very deep central tank sump

The sprayer is completely emptied even on slopes up to 10 degrees - up-hill or downhill

Easy to rinse inside with tank rinsing nozzles

100% of the tank can be "seen" by the agitation nozzles. No sharp corners prevent sedimentation of pesticide.

Easy to clean outside

The smooth surface of the tank makes the machine very easy to clean.

Material:
UV protected polyethylene

Material thickness
is 0.5

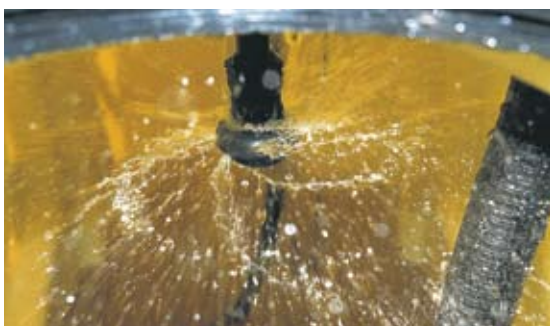

Rinse Tank



Material:
UV protected
polyethylene

Capacity:
130 gallon

Material thickness
is 0.33"



Capacity is 130 gallons on all machines

The same tank is used on all machines providing adequate liquid for both inside and outside cleaning.

Easy filling from the work zone

2" filling from the work zone is standard.

Placed on axle for added stability

The rinse tank is typically the last tank to be emptied. By locating it on the rear axle, extra stability is ensured.

Level indicator

The indicator is placed on the front of the sprayer to allow step by step cleaning.

Clean Water Tank



Capacity:
4.5 gallons

Well integrated

Clean Water Tank for hand washing
Integrated into the overall design to ensure easy cleaning at the work zone.

Easy filling operation from platform
The tank is filled from the platform through a large 2½" filling hole.

Overview - standard

Diagram - Liquid system

- | | |
|--------------------------------------|------------------------------------|
| 1. Suction SmartValve | 13. ChemFiller |
| 2. Pressure SmartValve | 14. Safety valve |
| 3. Agitation valve | 15. Ejector filling |
| 4. Chemical container cleaning valve | 16. Internal tank cleaning nozzles |
| 5. ChemFiller Vortex nozzle valve | 17. Agitation |
| 6. Pump | 18. Return line for boost function |
| 7. Main tank | 19. Return from section valves |
| 8. EasyClean filter | 20. RinseTank coupler |
| 9. RinseTank | 21. Pressure control valve |
| 10. Ejector | 22. One-way valve |
| 11. Cyclone filter | 23. Drain valve |
| 12. Distribution valves | 24. Sprayer boom |

The liquid system is a totally new design with large dimensions in all valves, tubes and filters.

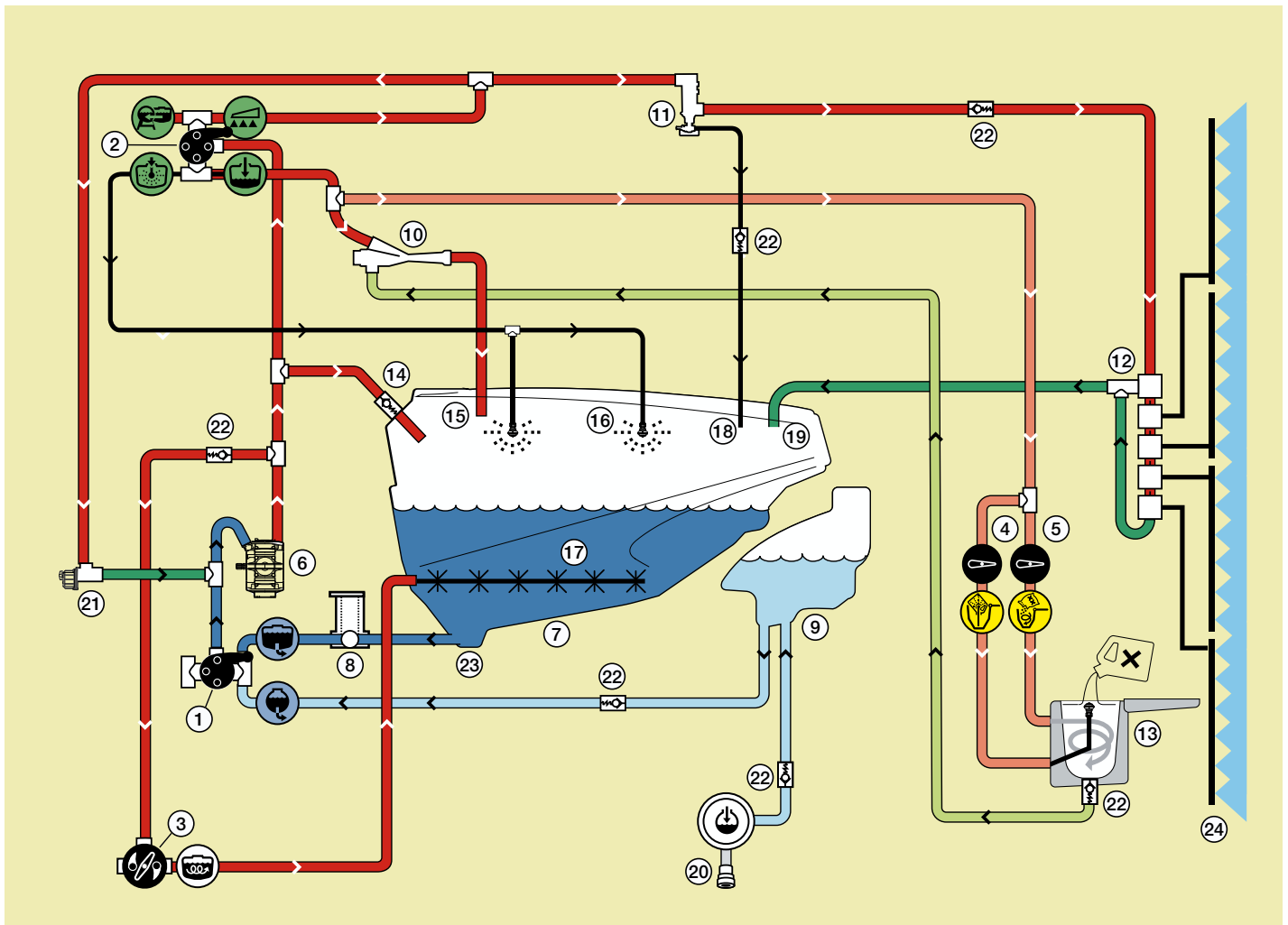

SmartValve



All primary functions needed to operate the sprayer when filling or cleaning, have been built into two handles located in the center of the work zone. The logically placed

handles and the easy to read color coded icons make the system very easy to understand and operate. Greatly reduces the start-up and operation time of the sprayer.

Fluid system

Suction



Suction from main tank



Suction from RinseTank

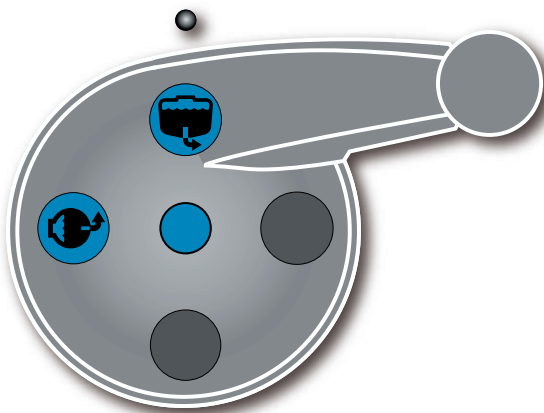

Pressure



Tank cleaning



Filling



Spraying

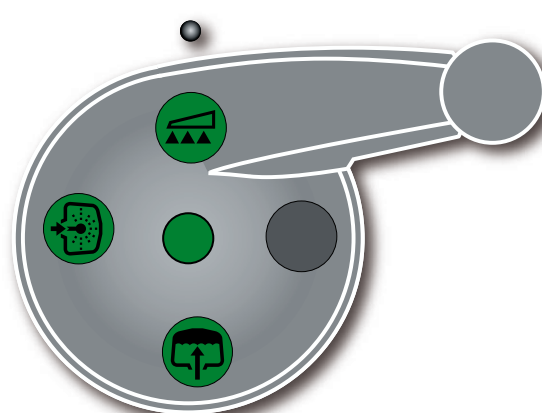

Pump

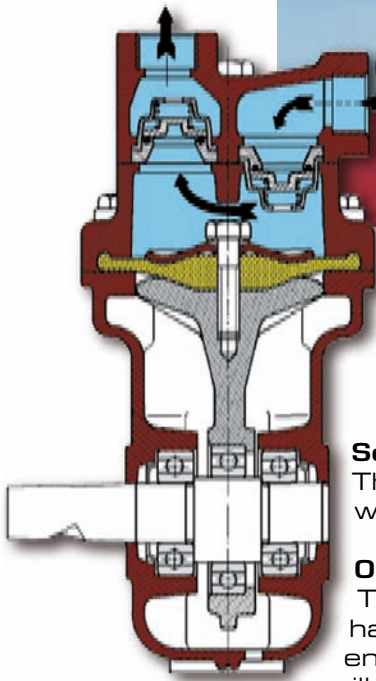
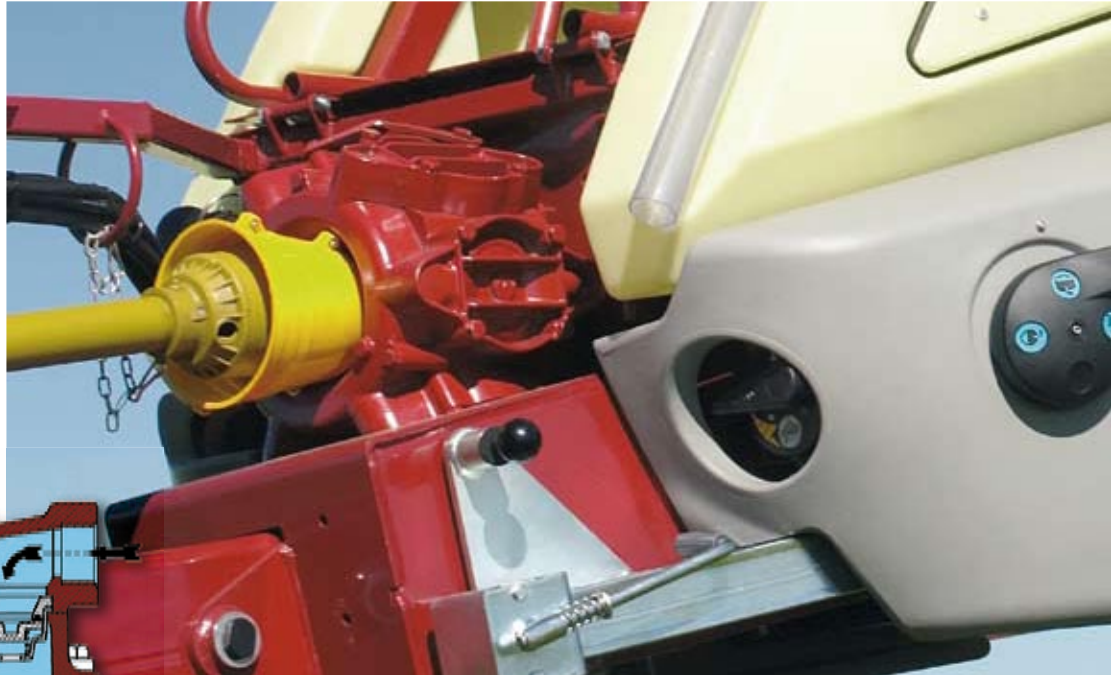

The new COMMANDER liquid system is driven by the robust grease lubricated HARDI diaphragm pump.

Self-priming

The pump is self priming and will start up in all conditions.

Open crank case

The unique HARDI pump has an open crankcase. This ensures that the crankcase will not hold chemicals, thereby avoiding fast destruction of the bearings and the crankshaft in case of an unlikely diaphragm failure.

Able to run dry without damage

The HARDI pump can run completely dry without any damage at all.

Easy service pump hanging from chassis

The pump is mounted in such a way that all diaphragms and valves can be serviced without removing the pump from the sprayer.

No contact between chemicals and moving mechanical parts

All moving parts are completely separated from the liquid running through the pump.

Pumps available for the COMMANDER

Pump	RPM	Stroke	Capacity
463H	1000	6.5 mm	89 GPM

Pressure control

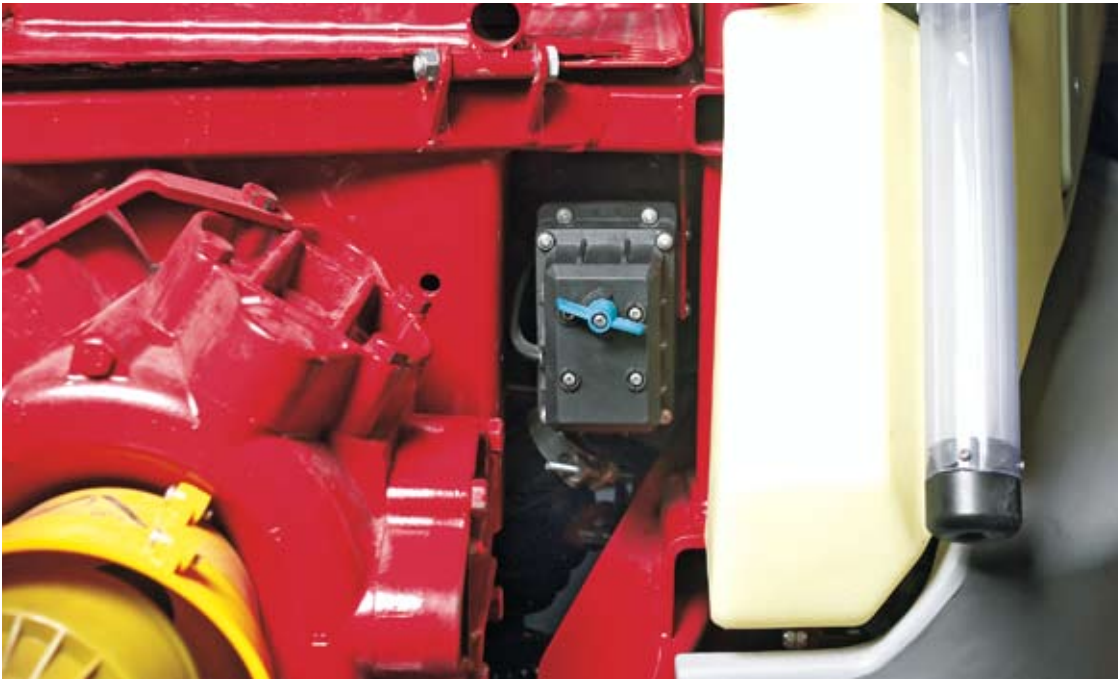

The pressure regulation system is based on a new high capacity, high-speed bypass valve. A bleed line in the valve causes constant flushing to prevent residue built-up in the valve.

Quick acquisition of correct setting

It is located at the front of the sprayer so it can be monitored. Equalization system is no longer necessary. Exceptional reliability from well proven HARDI electrical motors.

No internal residue built-up

More security when changing to a different type of pesticide.

Can be operated with the control box alone (no computer)

Eases trouble shooting.

Can be operated manually without electrical power

A "finish the job" feature should an in-field problem occur.

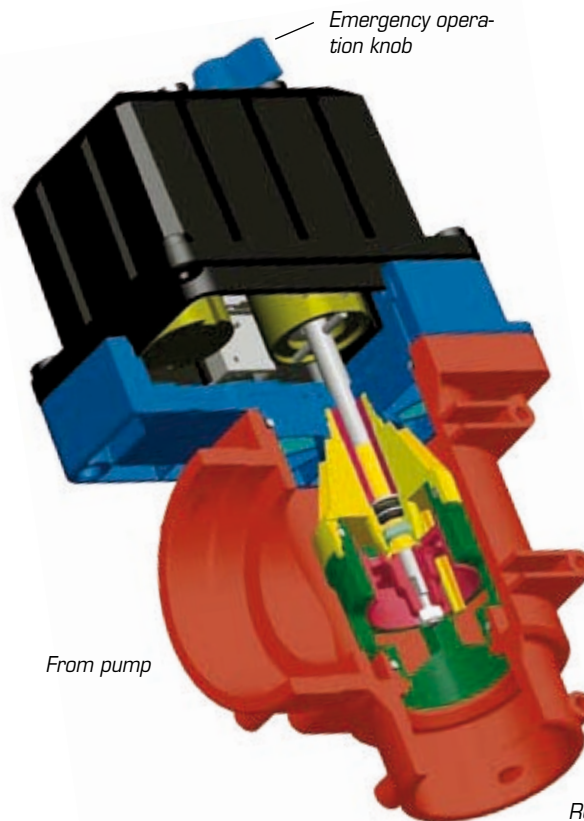

Maximum flow:
160 GPM at
12 PSI

Revolutions from
min. to max: 9

Revolutions per
second: 1

Fluid system

EasyClean filter



Surface area
228 in²

Flow capacity
118 GPM

Inlet diameter
2½"

Outlet diameter
2½"

Screen size:
30 mesh std.
50 mesh
80 mesh

The new HARDI EasyClean suction filter is a high capacity filter with a very large filter surface. The condition of the filter can be constantly monitored on an external gauge. This ensures that the filter is cleaned when needed and only when needed.

When opening the lid, the main valve is automatically turned to OFF

The automatic shut off valve ensures safe operation of the sprayer, without any risk of spill.

Condition of the filter can be monitored on vacuum gauge

The unique vacuum gauge ensures that the filter is cleaned when needed and only when needed.

Very high capacity

The filter has large screen surface ensuring a sustained high capacity.

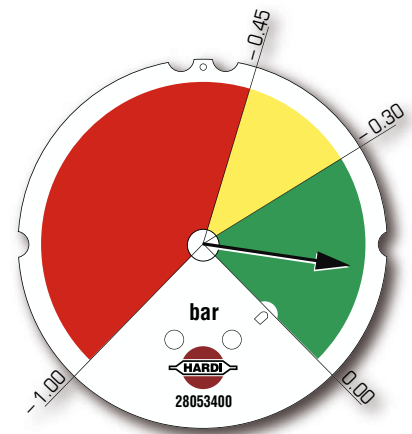

Filter is fitted in an upright position

The filter is fitted in such a position that it can be serviced from the ground, without any risk of spill.

Dirt trap inside the filter screen ensures that impurities are removed from the system

Two flaps inside the filter ensure that impurities will be removed when the screen is pulled out.

EasyClean filter

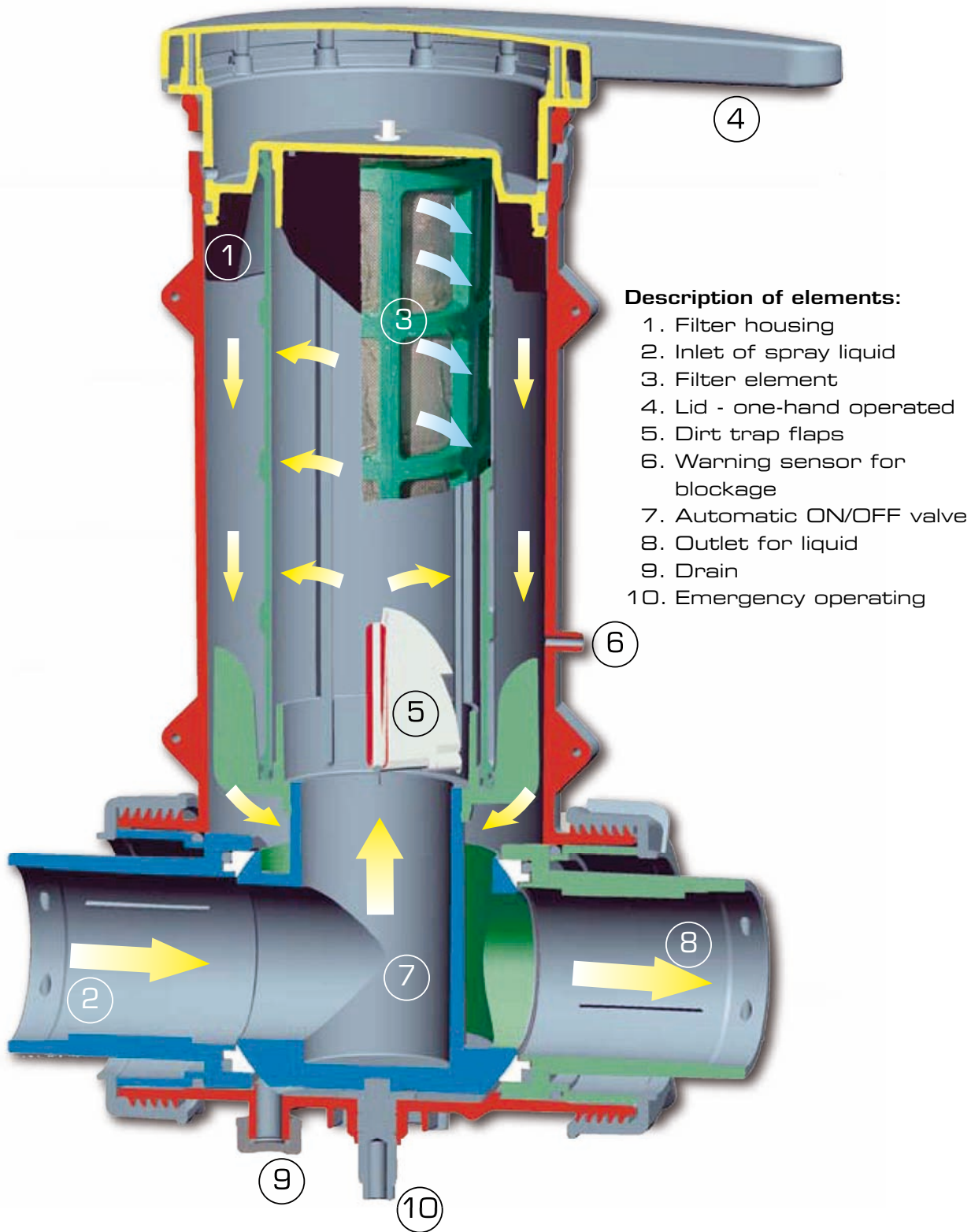

CycloneFilter



The new HARDI CycloneFilter is a unique self-cleaning pressure filter that uses a high-speed cyclone for additional cleaning action. The cyclone action increases the cleaning capacity of the filter significantly.

This ensures fewer stops and reduced pressure loss in the liquid system. The HARDI CycloneFilter furthermore has a unique boost function that allows the filter to be flushed "on-the-go" when needed.

Flow capacity:
105 GPM

Inlet diameter
1½"

Outlet diameter
1½"

Screen size:
50 mesh
80 mesh std.
100 mesh

Unique cyclone action greatly improves the self-cleaning action

The cyclone created inside the filter increases the speed of the liquid against the filter screen, thereby increasing the effectiveness of the self-cleaning action.

Filter is fitted in an upright position

The filter is fitted in such a position that spill can be avoided when inspecting the filter.

Valve with 3 positions (OFF/ON/Boost)

The control valve in the bottom of the filter can be positioned in 3 different modes:

- (•) Self-cleaning OFF
Used when all the flow from the pump is needed
- (••) Self-cleaning ON
- (•••) Boost
Used to flush the filter screen



CycloneFilter

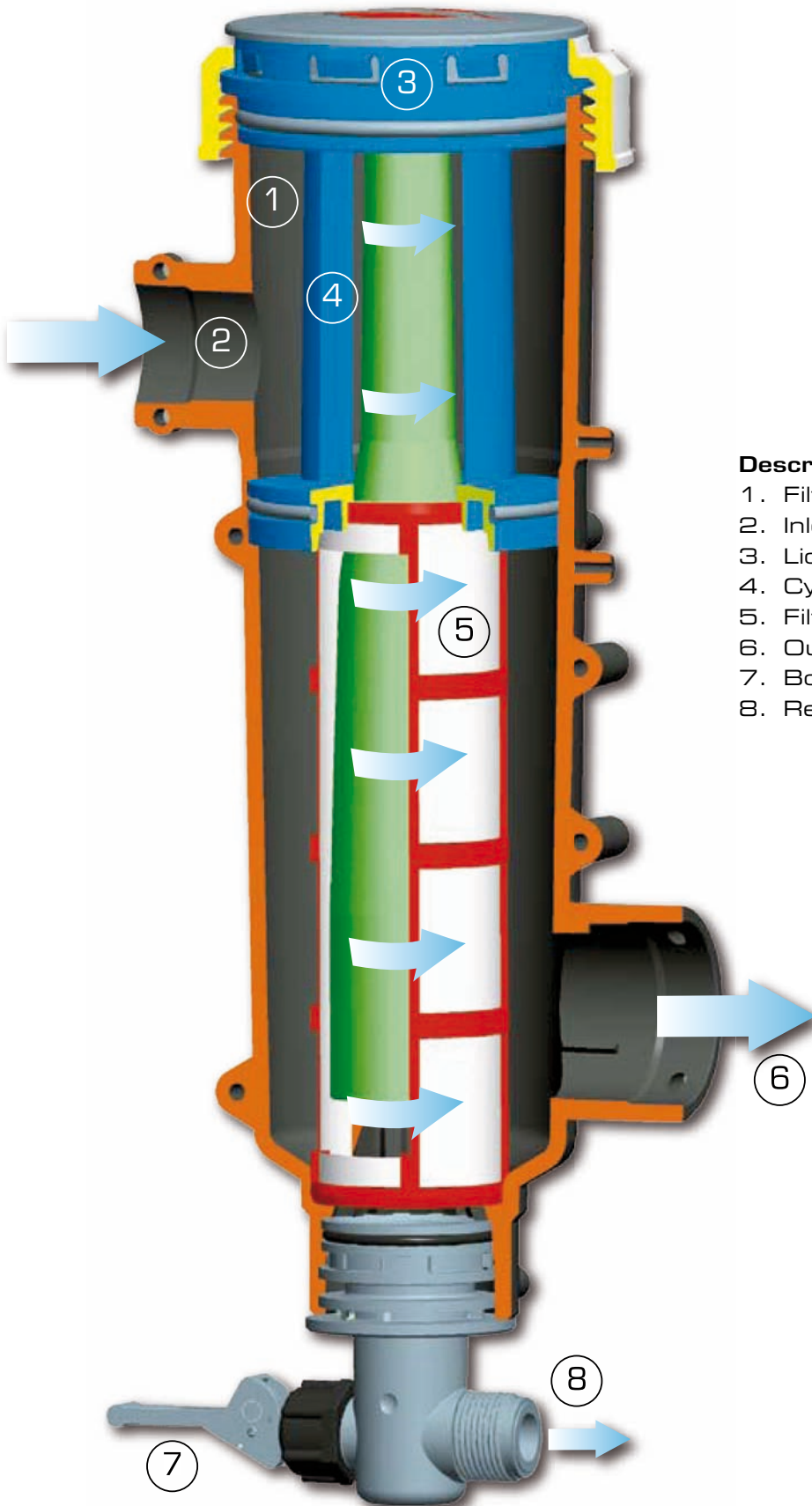

Description of elements:

- 1. Filter housing
- 2. Inlet of spray liquid
- 3. Lid - one-hand operated
- 4. Cyclone chamber
- 5. Filter element
- 6. Outlet of spray liquid
- 7. Boost valve
- 8. Return line

ChemFiller



The HARDI ChemFiller is standard on the COMMANDER and has been developed to handle large quantities of powders and liquids. The high capacity of the ChemFiller is achieved by using a combination of high vacuum and high pressure Vortex nozzles placed inside the hopper.

Filling capacity liquid up to 32 GPM

Size of hopper 9 Gal

High capacity Vortex action inside hopper

Liquid at high pressure is used to create a powerful Vortex inside the hopper. This Vortex will efficiently mix all powder and liquid chemicals before they are transferred into the sprayer.

Very high vacuum and suction capacity
A large external ejector system creates a powerful vacuum that transfers powders and liquid directly into the tank.

The sturdy lid can be used as work table

When the lid is opened, it can be used as a bench for measuring or storing the chemicals before mixing.



Rotating nozzle used for cleaning containers and the ChemFiller itself

The built-in rotating nozzle will clean any chemical container. After use the same nozzle will clean out the complete ChemFiller. The nozzle has a point that can penetrate the seal on most chemical containers.

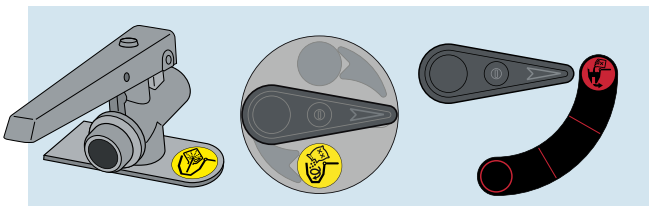

EFC boom section valves

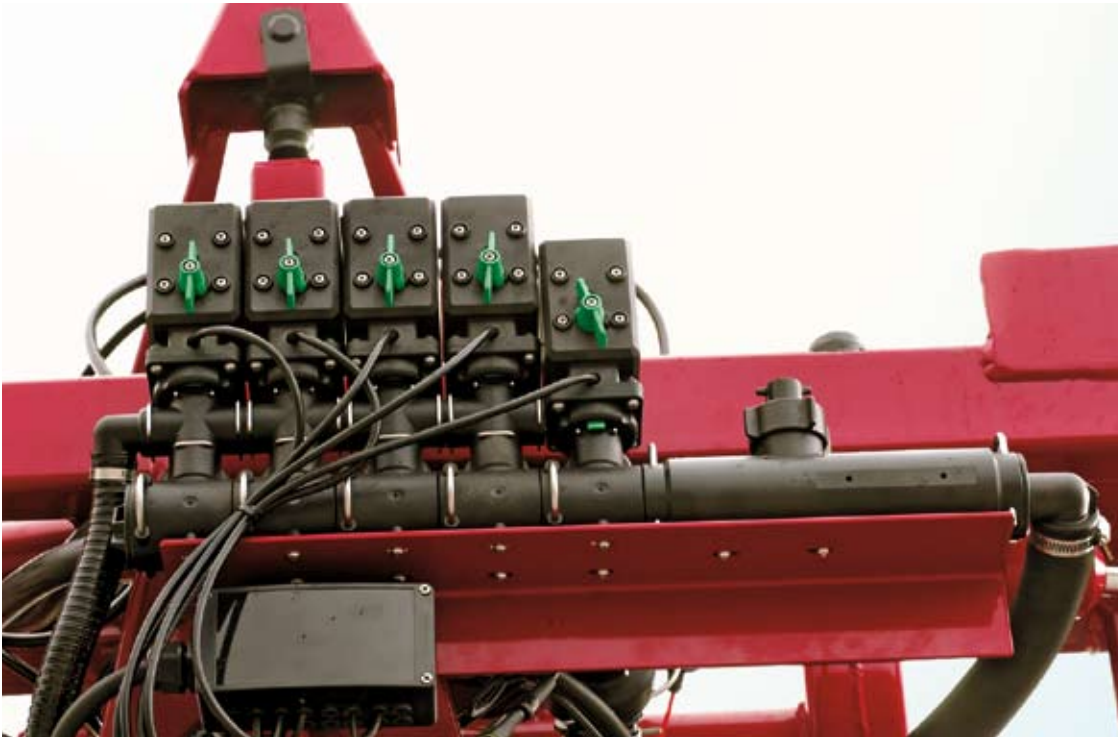

The new Electric Fast Control (EFC) is a modular system with a positive drive motor valve for each section and a single pressure dump valve when all sections are switched to OFF.

The section valves incorporate a pressure dump. When the section is switched to OFF, the pressure in the line to the nozzles is relieved. This results in instant shut-off at the nozzles.

The EFC does not need any form of adjustment e.g. pressure equalization.

Faster nozzle OFF, even with very small capacity nozzles

Incorporated pressure dump insures instant nozzle closure.

Radial sealing system

This is the best sealing system to guarantee no leaks.

Increased flow capacity

Larger diameter manifold to handle high application rates and larger boom widths.

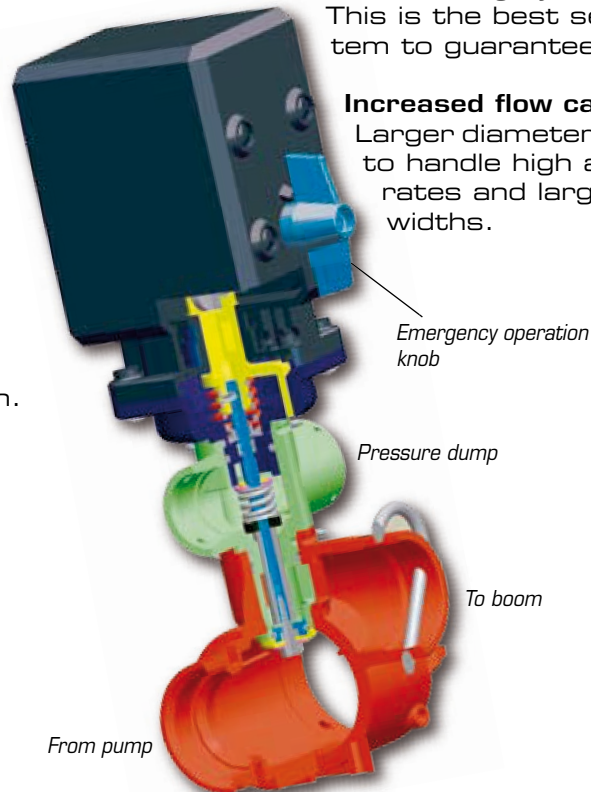

LookAhead pressure regulation

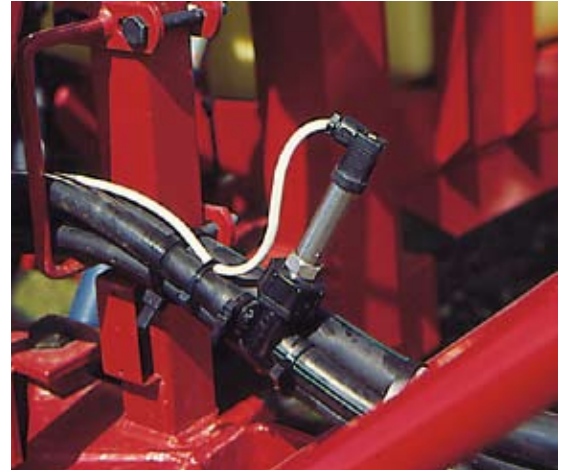

A regulation valve sensor records the position.

At power ON, it will automatically go from its current position to the minimum position and back again.

At power OFF, the system is reset.

Combined with a HARDI HC 5500 controller, the pressure regulation is constantly active, even when not spraying. Correct valve settings are anticipated, and when spraying starts, the programmed application rate is quickly reached.

The intelligent HARDI LookAhead system records the pressure valve position in relation to correct application rate and speed. The system remembers previous valve settings depending on operating conditions and re-uses this information the next time a similar condition occurs.

In combination with an electronic pressure transducer, flow rates

below the normal range of the flow transducer will be calculated on pressure and not flow. This may occur when only one boom section is open and the flow is under 2 gpm. It ensures accurate application even in extreme conditions.

Faster application rate reaction

Even at:

- A speed change while the main boom is OFF.
- Changes made to the programmed application rate. (e.g. from 15 to 20 gpa.)
- Spraying again after refill.
- Individual sections are switched to OFF with the main boom switch OFF.

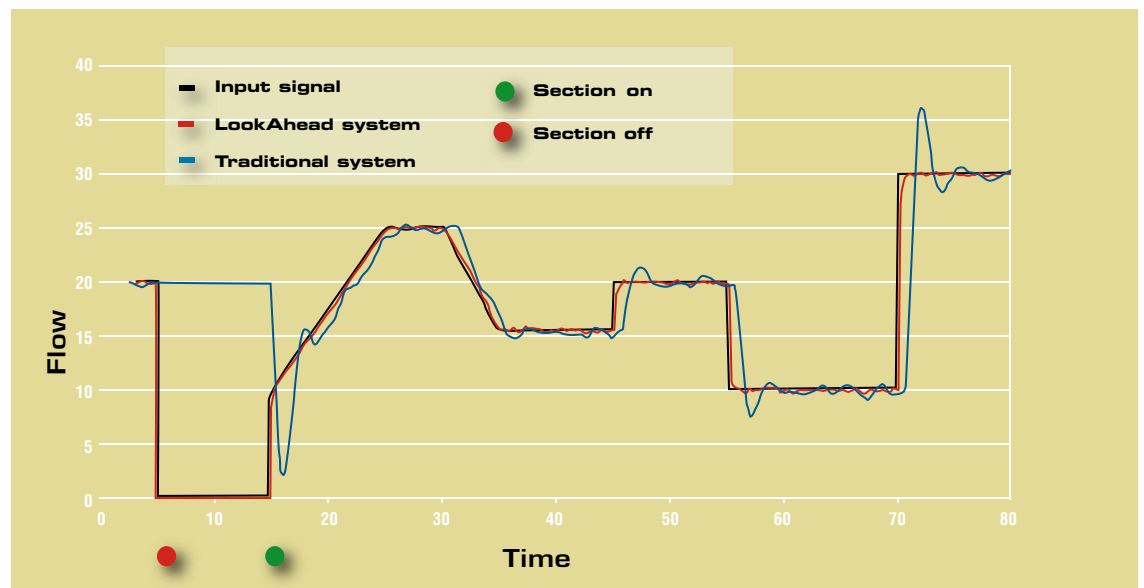

Control box units



The control boxes are compact, ergonomically designed units that allows the operator's right hand to naturally rest around the right side of the box. The logical switch layout puts all frequently used functions at the operator's fingertips.

The supplied pillar bracket, designed for ISO mount points, is quick to fit to the tractor. A wing bolt releases the boxes for quick removal. A single 39-pin plug is connected to the box. Cable diameter is 1/2".

On the new Spray II box, the foam marker and TWIN functions have dial-up visual pre-sets to ease setting changes.

Large color-coded switches

Switches are easy to identify and use. Foam marker, end nozzles and an "A-B" switch are included for optional operator specific functions.



Thermal fuses

No need to replace mechanical fuse if a short circuit has occurred.

Emergency operation of the sprayer possible

The boxes can operate the basic sprayer functions without the computer.

Control box units

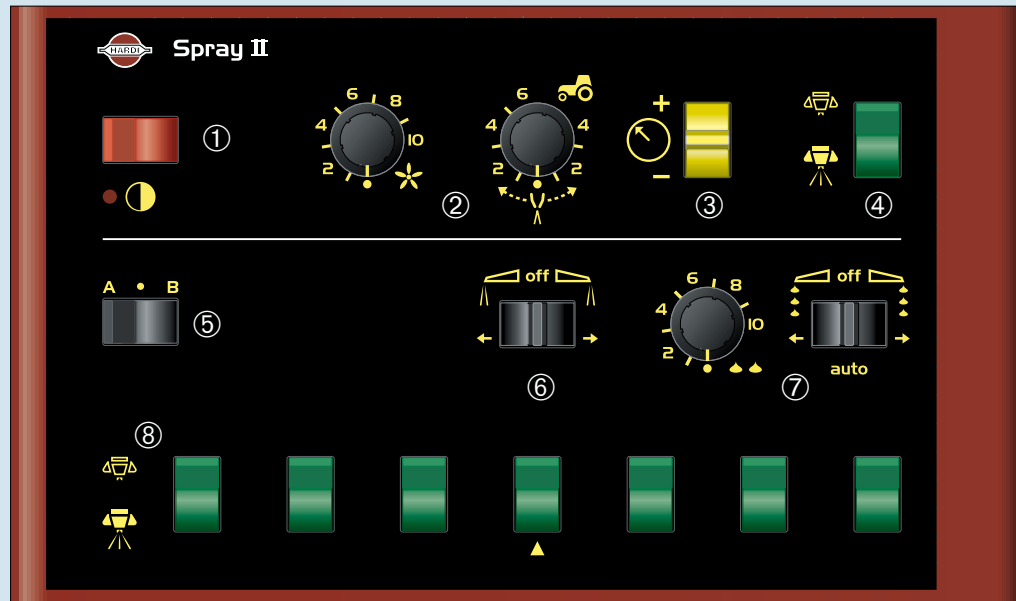

Spray box II

- | | |
|-----------------------------|------------------------|
| 1. Power switch | 5. Options control |
| 2. TWIN control (TWIN only) | 6. End nozzle control |
| 3. Pressure regulation | 7. Foam marker control |
| 4. Main ON/OFF | 8. Boom section valves |

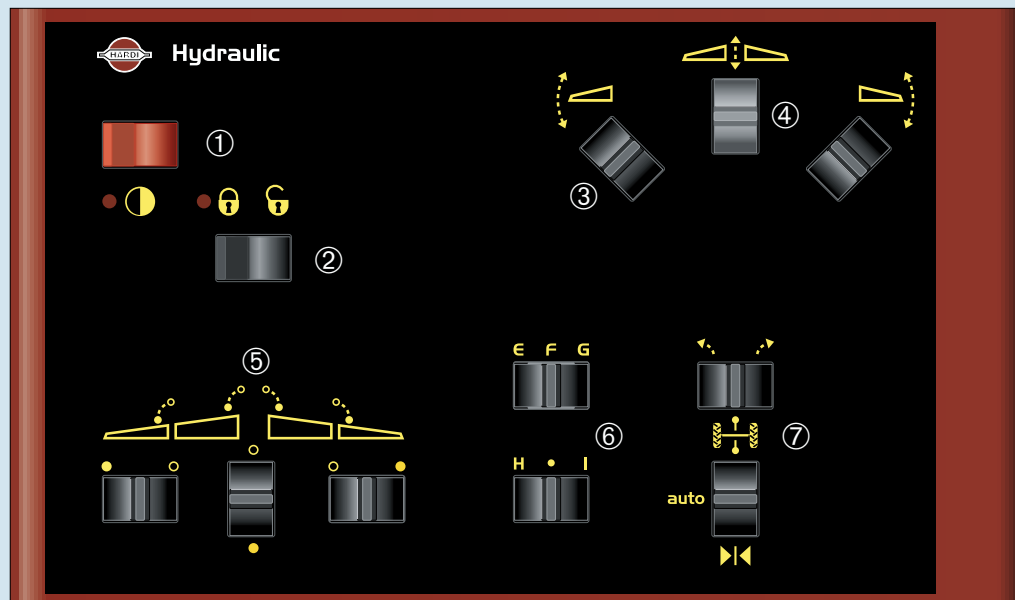

Hydraulic box

- | | |
|--------------------------------|---------------------|
| 1. Power switch | 5. Boom fold |
| 2. Pendulum or trapeze control | 6. Options control |
| 3. Tilt | 7. Tracking control |
| 4. Boom raise/lower | |

Actual size: 8½" x 5" x 3¼"

HC 5500 Controller



HARDI Controller 5500 is the choice when features like Look Ahead pressure regulation, HARDI SafeTrack steering and advanced farming tools are desired.

It can also automate functions, like the foam marker. Furthermore, the operator is instantly informed on

operation status and warned when vital parameters, like pressure, speed, etc. are not correct.

It is advanced farming ready with up to 98 registers, connection possibility with a site specific application map or a remote sensor and use with a 12 volt printer.

Compact display with 4 lines of information

Readable in bright sunlight and is suitable for night spraying.

Freedom of placement

It can be located in the operators' line of travel.

Pre-set keys for vital information access

Information appears in the large format area of the screen. They double up as short cut keys for most used functions.

Volume rate can be changed on the go as a percentage or volume value.

Distance or area left readout

The distance or area left is constantly calculated.



Emergency operation possible

The basic sprayer functions can be operated without the computer.

Actual size:
8½" x 5" x 3¼"

Display readout:
Activity status
Active sections
Register number
Volume rate
Speed
Tank contents
Area treated
Total volume sprayed
Distance/area left
Programmed and actual volume rate
Flow rate
Actual time
Work rate
Optionals readout

Boom survey

TWIN FORCE boom:

- 100 ft - 5 section
- 90 ft - 4 section
- 88 ft - 4 section
- 80 ft - 4 section



The HARDI TWIN booms offer the ultimate in capacity, weather independence and application technology.

The ideal high capacity solution for most users. The TWIN is available in sizes from 80 to 100 ft.

FORCE boom:

- 132 ft - 7 section
- 120 ft - 7 section
- 100 ft - 7 section
- 90 ft - 5 section
- 88 ft - 5 section
- 80 ft - 5 section



The HARDI FORCE is top of the line in conventional spraying, available in 80 to 132 ft. The HARDI FORCE is the perfect choice for large-scale

farmers and contractors looking for unmatched performance and dependability. The rugged three-dimensional structure guarantees unrivalled durability.

EAGLE boom:

- 100 ft - 4-5 section
- 90 ft - 4-5 section
- 88 ft - 4-5 section
- 80 ft - 4-5 section



The HARDI EAGLE boom is available in 80 to 100 ft and is the ideal

choice for the operator looking for durability and value.



TWIN FORCE



FORCE



EAGLE

Suspension

TWIN FORCE and FORCE

1. Coil spring

Two large coil springs and damper, damping movements directly up and down from the field.

2. Trapeze arms

The trapeze dampens fast side movements and keeps the boom horizontal.

3. Trapeze dampening

A hydraulic dampening cylinder that is fully adjustable dampens the trapeze.

4. Guide rods

The sensitivity of the trapeze can be adjusted by moving the guide rods. Ensuring a perfect boom ride under all conditions.

5. Anti Yaw

A unique Anti Yaw system dampens the forward and backward horizontal movements as well as any horizontal shock load.

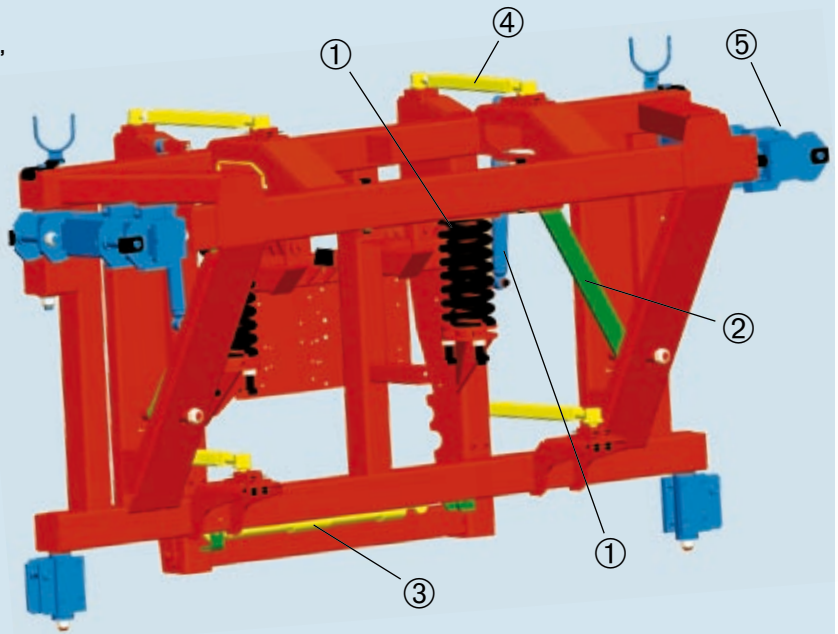

EAGLE

1. Coil spring

The large coil springs and damper, helps dampens the movements up and down from the field.

2. Trapeze arms

Trapeze arms work together with the coil springs to provide exceptional boom ride.

3. Self Stabilizing

All Eagle boom feature a self stabilizing center section to accommodate all terrains

4. Anti Yaw

Yaw Dampening of horizontal movements are integrated through 4 individual rubber buffers located on the center section. This protects the boom in the toughest conditions.

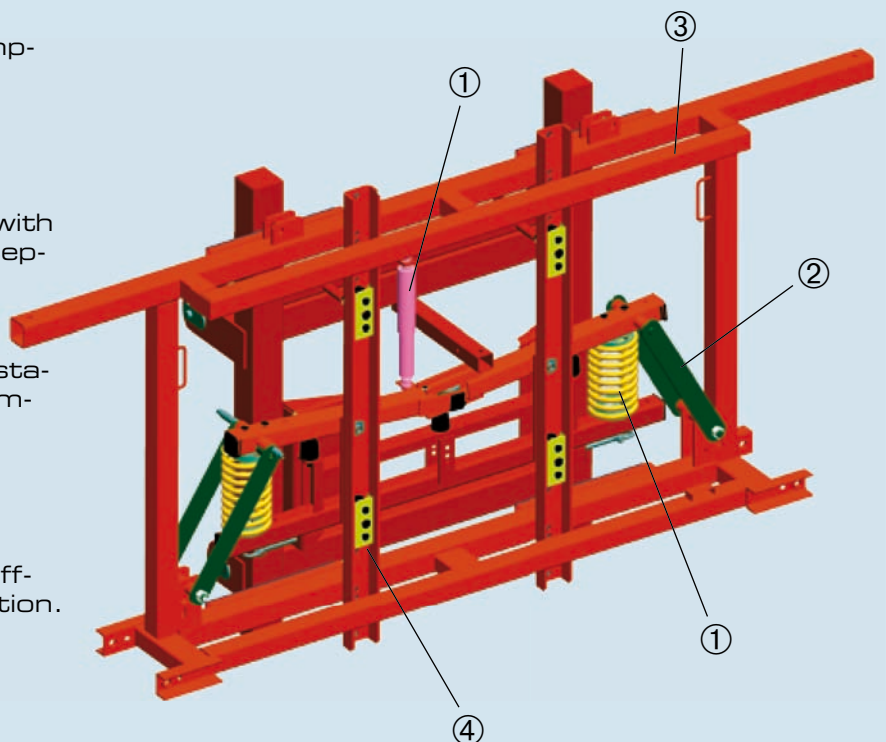

Hydraulic

EAGLE

Require

- 1 single hydraulic outlet for up/down
- 1 double hydraulic outlet for fold

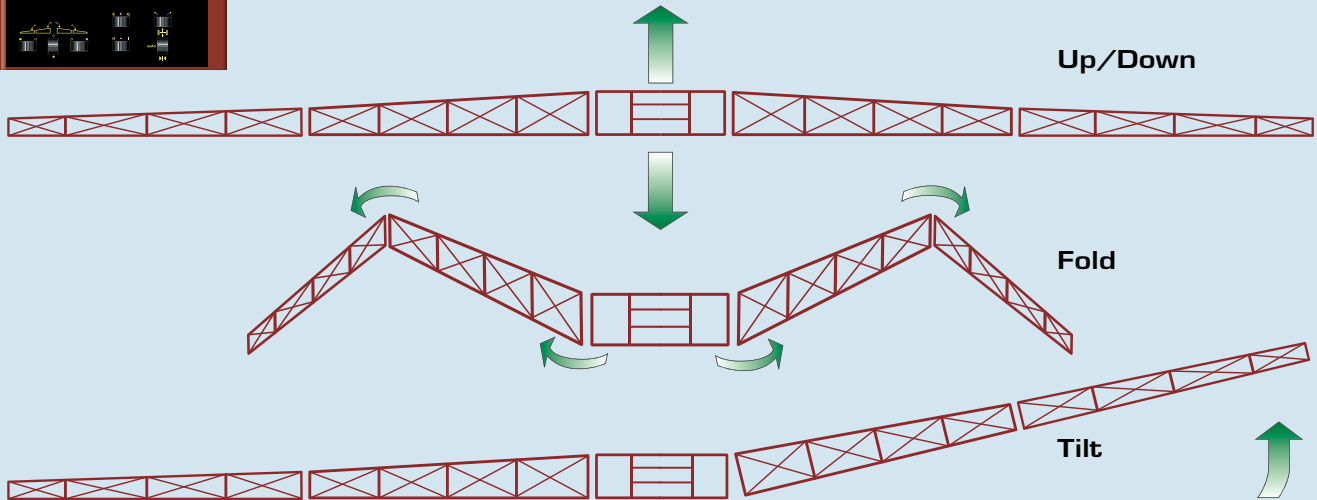
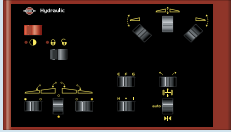

FORCE/TWIN FORCE

Require

- 1 double hydraulic outlet

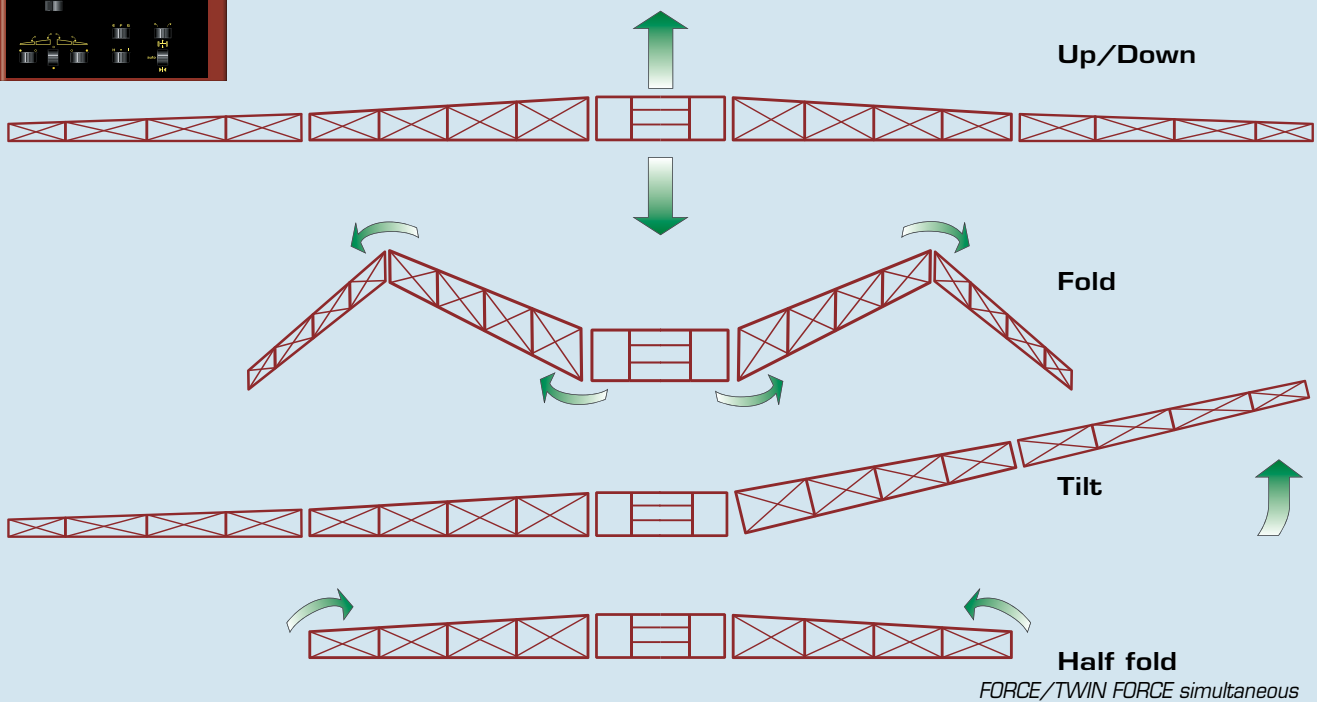
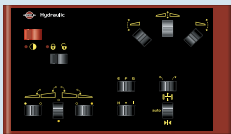

Boom wings

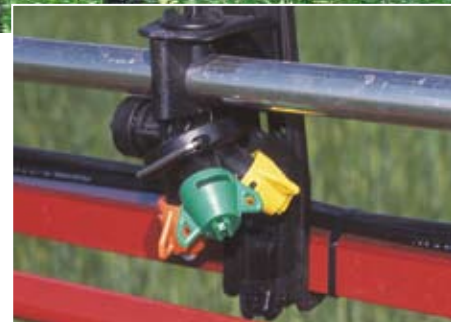
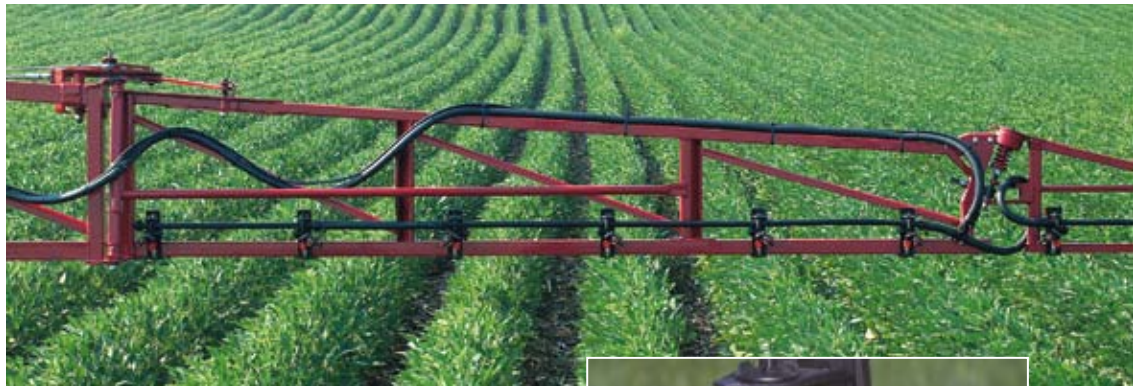

Three dimensional design

This design also ensures a very rigid boom with a minimum of unwanted horizontal boom movements that could otherwise lead to misapplication.

Over center locking mechanism

This combined with the three dimensional design provides a very rigid boom, ensuring a minimum of boom movements and very accurate application.

Stainless steel boom tubing

On TWIN FORCE and FORCE booms, stainless steel boom tubing is standard. This ensures both durability and high flow capacity on the boom.

Protected nozzle holders

Well protected TRIPLET nozzle holders are standard.

Breakaway

A multi directional spring loaded breakaway system protects the boom from damage.

TWIN FORCE boom sections

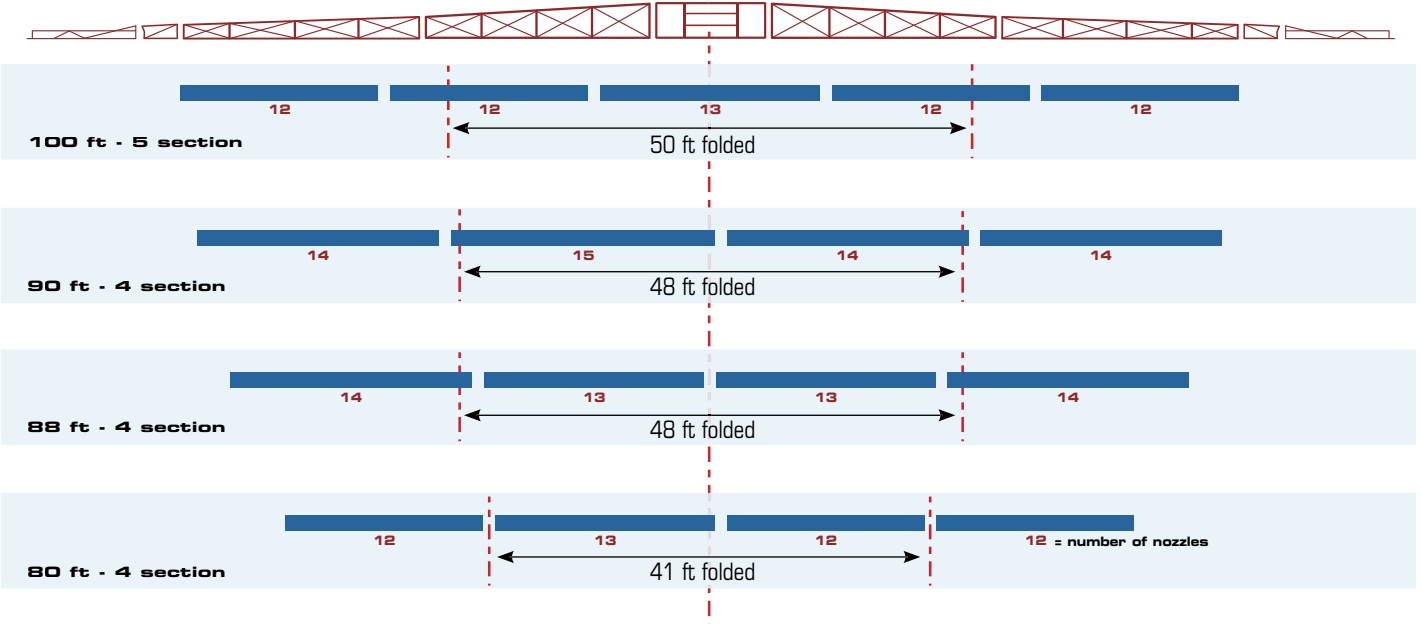

FORCE boom sections

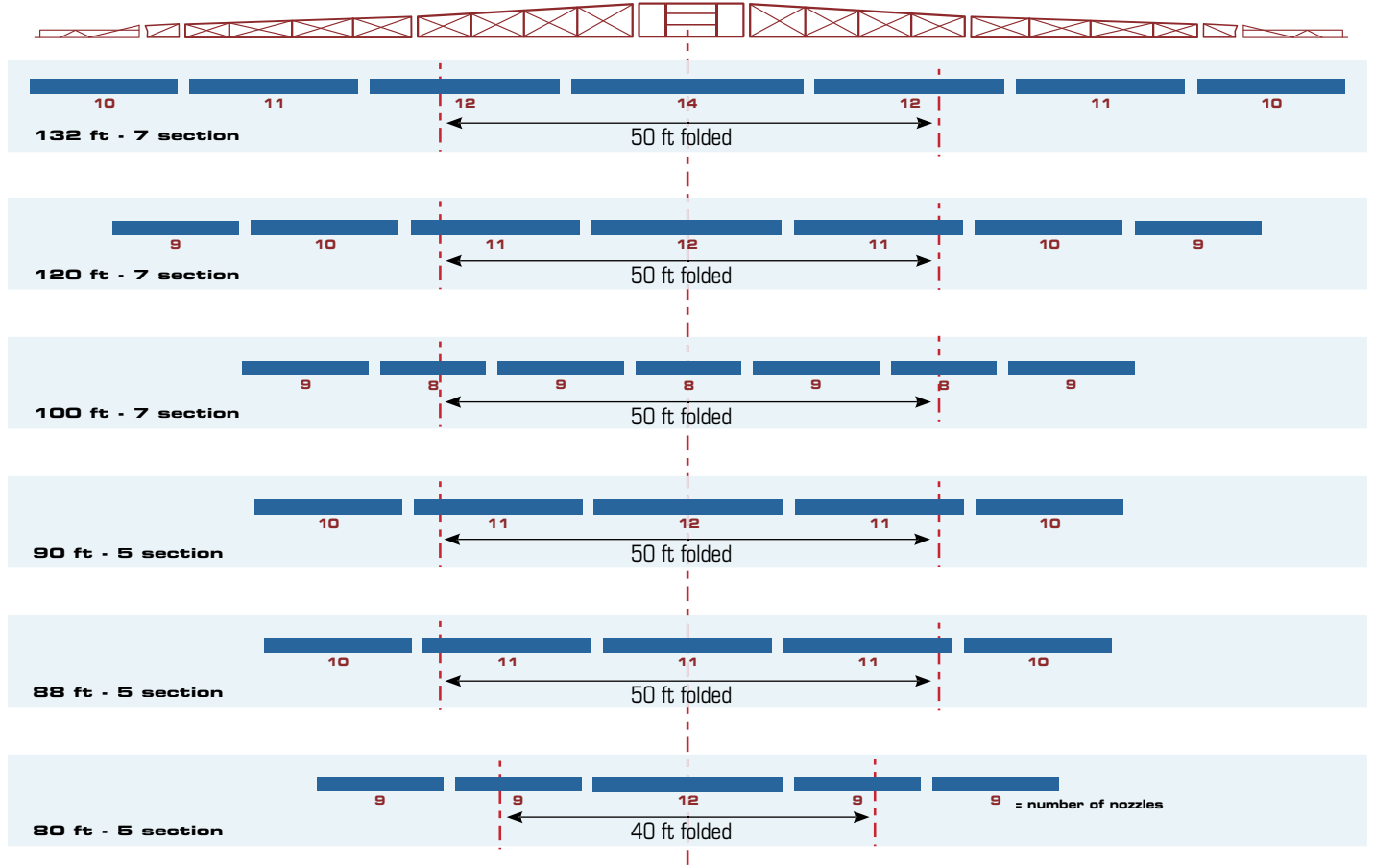

EAGLE boom sections

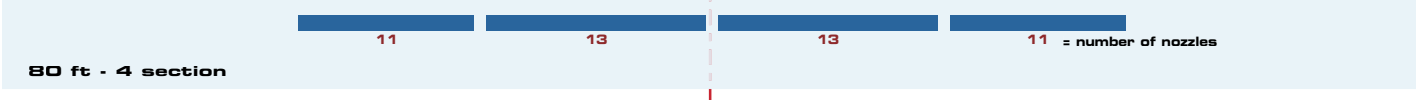
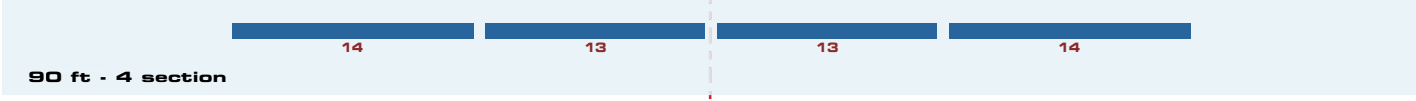

TWIN



110° flat fan nozzles spray into a continuous air curtain at a fixed angle to ensure uniform liquid distribution and optimal use of the air assistance.

The unique co-angling of air and nozzles compensates for changing wind directions and optimises plant deposits.



Forward angling up to +40°

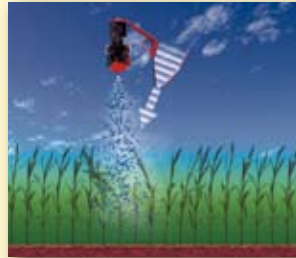

No angling



Backward angling up to -30°

Faster spraying speeds - by more than 50%

Farmers around the world exploit faster spraying speeds to obtain higher capacity. Going up in spraying speeds increases the drift cloud behind the sprayer on conventional sprayers.

The active air assistance forces all the droplets down onto the target surface, and through crop canopies when needed - to both avoid drift but also secure the swath wide distribution.

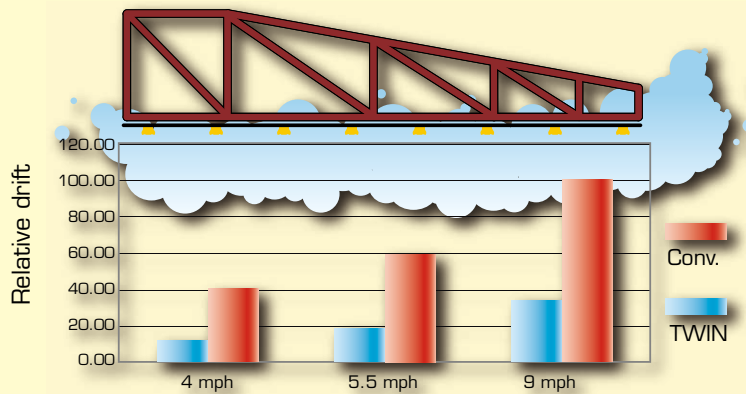

Total drift. FFO25 at 30 psi: 4 mph - 17 gpa 5.5 mph - 12 gpa 9 mph - 7 gpa Wind velocity: 4 - 8 mph

(HARDI International, 2003)

Sprayers are getting bigger and going faster. These trends with conventional sprayers are causing drift concerns, poorer distribution and raising residue fears in high value crops. Poor distribution in the field will affect chemical performance, can cause crop damage and will risk yield loss. TWIN sprayer users will not have these concerns.

TWIN

Spraying hours in 2000-2003

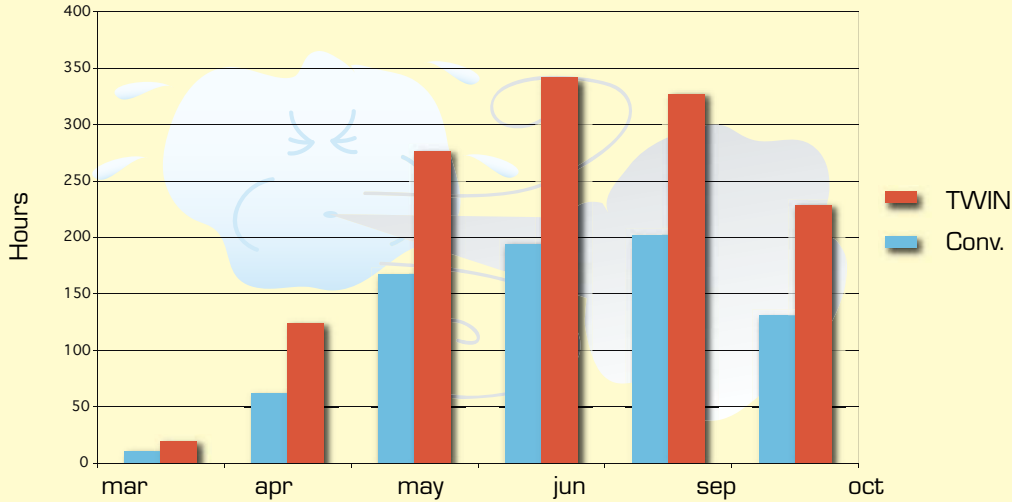

Get 50% more available spraying hours

Spray drift from conventional sprayer can be so great that the operator has to stop before having the spray job done. With efficient drift control it is much easier for the operator to be able to spray the entire field.

Under most conditions the farmers get at least twice as many hours for a safe and efficient spray job with the TWIN sprayer compared to conventional spraying. Maximum wind speed for conventional spraying is estimated to 9 mph and for TWIN 18 mph.

Optimal field timing

When spraying for weed, fungi and insect control, the highest effect is gained when spraying the pest at the most vulnerable stage. Field timing is the key to getting the best biological effects and is the most secure route to reduced doses. Herbicide doses can often be reduced considerably if the target weeds are at the cotyledenous stage - a difficult challenge since only a few days are then available. These few opportunities to spray are limited with conventional sprayers because of wind or losing time hauling large water volumes to the field. TWIN sprayers increase possibilities to spray in higher winds and gain maximum spraying time in the field too.

Lower water volume - saves at least 50%

HARDI ISO F 110

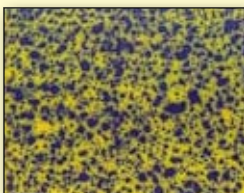

15 gpa

HARDI ISO LD 110

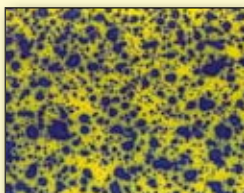

15 gpa

HARDI INJET

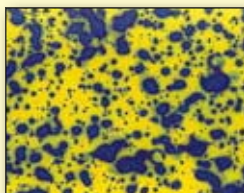

15 gpa

HARDI TWIN



7.5 gpa

ChemLocker

4400 machine
Width 22"
Depth 17¼"
Height 10"

Load capacity:
220 lb



A HARDI ChemLocker is a sprayer mounted storage locker for chemical containers or bags.

Night spraying lights



Lights can be fitted to ease spraying and mixing done at night.

External Cleaning Kit



For external cleaning in the field a cleaning kit can be fitted. This allows for safe cleaning of the complete sprayer in the field.



**Use of clean water
at 220 psi:
6½ GPM**

**Use of clean water
at 70 psi:
4 GPM**

**Length of 3/8"
hose: 65 ft**

**Max pressure is
220 psi**

Options

Foam marker



Tank capacity
25 gal

The HARDI Electric remote foam marker has been upgraded to the new COMMANDER and can be fitted instead of HARDI ChemLocker. A much larger tank greatly extends the work capacity.

The Spray II control box has a rotary knob to adjust the amount of foam produced. This offers the operator a pre-set function.

Visual pre-set of foam quantity

Controls integrated in the Spray II control box

High capacity foam liquid tank

The foam-metering unit (needle valve and small motor) is removed and the electronics is now a single sealed module. The foam quantity is now metered electronically.

As an alternative or for booms over 80 ft , the HARDI E-Z Guide Plus guidance system can be used.

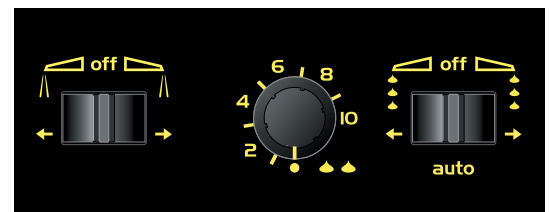

Operated from Spray box II

Nozzles

HARDI spray nozzle selection guide

The HARDI ISO nozzle series is the most complete nozzle series on the market. This full range ensures that nozzles of all relevant sizes are available for all spray jobs.

HARDI ISO – Standard-Flat Fan nozzle (F)



The essential, multi-purpose Flat Fan nozzle. Ensures maximum coverage and superior uniform distribution in most situations. These nozzles can be recommended for all pesticide applications.



HARDI ISO MINIDRIFT – Air Inclusion nozzle (MD)

HARDI MINIDRIFT makes it possible to change from Medium to Coarse/Very Coarse just by turning the TRIPLET - pressure and volume rate will stay the same - and the spray job can be finished even at higher wind speeds.

HARDI ISO – LowDrift-Flat Fan nozzle (LD)



LowDrift nozzles are recommended when optimal spraying conditions can not be achieved yet spraying cannot be postponed. These nozzles have less Very Fine (driftable) droplets.



HARDI INJET – Air Inclusion nozzle (INJET)

The mix of air and water gives these nozzles a very coarse droplet spectrum, which will remarkably decrease the risk of drift. Recommended for very wind tolerant applications of soil applied and systemic pesticides.

HARDI QUINTASTREAM 5-hole nozzle (Q)



For applying liquid fertilizer. This new (patent pending) HARDI designed nozzle series can uniquely ensure a uniform distribution at boom heights from 35 - 100 cm. The easy way to turn your sprayer into a high precision fertilizer applicator.



ISO number/ color	Spray quality	GPM	GPA at MPH												
			5	6	7	8	9	10	11	12	15	20	25		
0075-Pink	F - - -	0.075	4.5	3.7	3.2	2.8	2.5	2.2	2.0	1.9	1.6	1.4	1.2		
01-Orange	F M - VC	0.100	5.9	5.0	4.2	3.7	3.3	3.0	2.7	2.5	2.1	1.9	1.7		
015-Green	F M C VC	0.150	8.9	7.4	6.4	5.6	5.0	4.5	4.1	3.7	3.2	2.8	2.5		
02-Yellow	F M C VC	0.200	11.9	9.9	8.5	7.4	6.6	5.9	5.4	5.0	4.2	3.7	3.3		
025-Lilac	M M C VC	0.250	14.9	12.4	10.6	9.3	8.3	7.4	6.8	6.2	5.3	4.6	4.1		
03-Blue	M C C VC	0.300	17.8	14.9	12.7	11.1	9.9	8.9	8.1	7.4	6.4	5.6	5.0		
04-Red	M C VC VC	0.400	23.8	19.8	17.0	14.9	13.2	11.9	10.8	9.9	8.5	7.4	6.6		
05-Brown	M C VC VC	0.500	29.7	24.8	21.2	18.6	16.5	14.9	13.5	12.4	10.6	9.3	8.3		
06-Grey	C - - VC	0.600	35.6	29.7	25.5	22.3	19.8	17.8	16.2	14.9	12.7	11.1	9.9		
08-White	C - - VC	0.800	47.5	39.6	33.9	29.7	26.4	23.8	21.6	19.8	17.0	14.9	13.2		
10-Light blue	C - - -	1.000	59.4	49.5	42.4	37.1	33.0	29.7	27.0	24.8	21.2	18.6	16.5		
15-Light green	- - - -	1.500	89.1	74.3	63.6	55.7	49.5	44.6	40.5	37.1	31.8	27.8	24.8		

All values are at 40 PSI

Spray quality: F = Fine, M = Medium, C = Coarse, VC = Very coarse, S = Solid stream

Pressure range: For F, LD, MD and G is 20 to 70 PSI (20 to 50 PSI recommended) and for INJET 40 to 120 PSI (40 to 80 PSI recommended).

Technical specifications

COMMANDER	4400	6600
Tank, gallon	1200	1850
Pumps, type – GPM	463H – 85	463H – 85 / 2X463 – 160
Booms	EAGLE, FORCE and TWIN FORCE	EAGLE, FORCE and TWIN FORCE
Suspension	Optional	Standard
Suspended drawbar	NA	Standard
Hydraulic outlets needed (HZ models)	1 single + 1 double acting	1 single + 1 double acting
Hydraulic outlets needed (DAH models)	1 double acting	1 double acting
Weight drawbar (empty tank)*, Lbs	1,540	2,680
Weight axle (empty tank)*, Lbs	8,640	10,160
Weight total (empty tank)*, Lbs	10,180	12,840
Turning radius SafeTrack, feet	20	29
Total length, feet	A 25.5	27.9
Total height, feet (320/90 x 50)	B 13	13.7
Width with TWIN FORCE, feet	C 9.8	9.8
With with EAGLE and FORCE, feet	C 11.5	11.5
Track width, inches (320/90 x 50)	D 60 - 90/120 fixed	60 - 90/120 fixed
Length draw to axle, feet	E 17.4	19.8
Clearance under axle, feet	F 2.6	2.5
RinseTank, gallon	130	130

* Weight is with 90 feet TWIN FORCE boom on the 4400 and 100 feet TWIN FORCE boom on 6600.

The COMMANDER is available with a range of booms from 80 to 132 feet. All booms have patented HARDI boom suspension with anti yaw dampening and are fully adjustable to suit both rough and steep terrain.

EAGLE 80 - 100 feet

The EAGLE boom shares most of the features from the FORCE range, and is available in boom sizes 80 to 100 feet. The EAGLE is the perfect choice for the medium to large farm.

FORCE 80 - 132 feet

The FORCE is developed for large scale farming and demanding field conditions. The FORCE boom will meet the tough demands from farmers world-wide

TWIN FORCE 80 -100 feet

The TWIN FORCE offers the strength and durability as the FORCE boom combined with the advantages of HARDI's unique TWIN air system. The TWIN system allows for faster spraying speeds, better penetration into difficult crops and spraying when conditions with a conventional sprayer would be marginal.

