

LANDSCAPING EQUIPMENT

Farm King



FOR TRACTORS 12 HP TO 225 HP

MOWERS | CUTTERS | TILLERS | COMPACT IMPLEMENTS | SNOWBLOWERS | REAR BLADES





FARM KING LANDSCAPING EQUIPMENT

FARM KING PRODUCT CATEGORIES

Grain Handling

Tillage

Application Equipment

Hay Tools

Landscaping Equipment

Allied by Farm King

Commercial Equipment

WWW.FARM-KING.COM

FARM KING HAS BEEN BUILDING EQUIPMENT FOR THE AGRICULTURE INDUSTRY FOR MORE THAN 70 YEARS.

Known for dependability and value, Farm King manufactures a wide array of landscaping equipment for tractors starting at 12 hp, all of which are quick hitch compatible.

Farm King landscaping equipment has undergone years of testing and refinement and is built to be rugged and long lasting.



TABLE OF CONTENTS

Finishing Mower 4-7

Flex-Wing Rotary Cutter ... 8-9

Rotary Cutter 10-11

Rotary Tiller 12-13

Box Scraper 14

Landscape Rake 15

Drag Harrow 16

Disc 17

Cultivator 18

Post-Hole Digger 19

Post Driver 20-21

Rear Blade 22-24

Quick Hitch 25

Snowblower 26-31

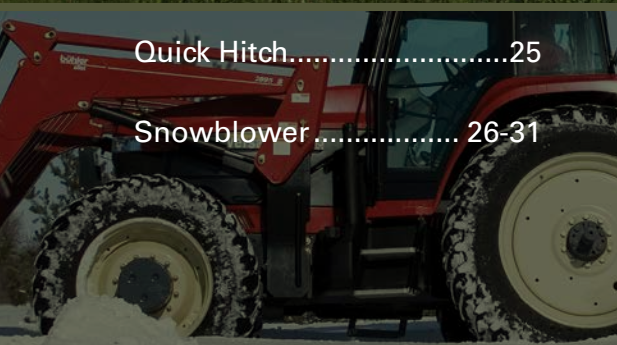
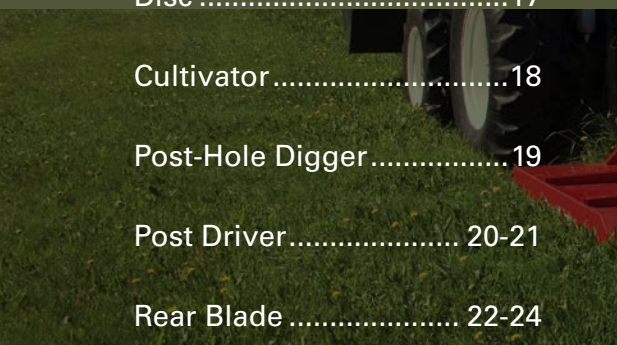
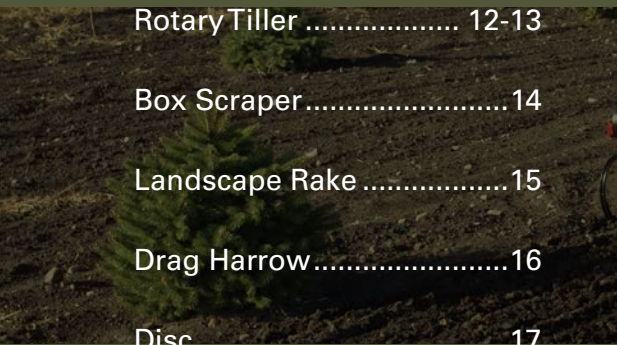

FINISHING MOWER



HOME-OWNER MODELS 430 // 530 // 630

PRODUCT OVERVIEW

- Built for lawns and acreages
- Category I
- 12 to 30 hp required

FEATURES

- Independent axle beams
- Quick hitch compatible
- Steel tube front roller
- Alloy steel hardened blades

OPTIONS

- UHMW poly roller prevents scalping
- Solid rubber tires
- Hard-surfaced blades
- Chain kit
- Solid rubber tires
- PTO shaft, heavy-duty

AVAILABLE COLORS



*Red is the standard color.

THE FARM KING HOME-OWNER FINISHING MOWER SERIES WAS DESIGNED AS AN ECONOMICAL CHOICE FOR USE ON LARGE ACREAGE HOMESTEADS.

These finishing mowers are quick hitch compatible and are available in widths ranging from 48" to 72" for tractors from 12 to 30 hp.

Farm King has been building top quality finishing mowers for 15 years and has refined these mowers to be among the best in the industry. Independent axle beams allow for quick replacement of parts while the optional solid rubber tires can easily withstand frequent heavy use. An optional chain kit minimizes the possibility of flying debris.

BLADES

Each mower features three high-speed blades with one of the highest rated tip-speeds in the industry. This creates powerful suction that lifts the grass for a crisp cut. A blade overlap of 1-5/8" to 2-5/8" prevents stripping and ensures the lawn is mowed evenly. Three, high-speed blades constructed from 1/4" x 2-1/2" alloy hardened steel are standard with optional hard-surfaced blades.



Model 430 - 4' (1.2 m) cutting width, 3-point hitch Category I
For tractors 12 - 25 hp

Model 530 - 5' (1.5 m) cutting width, 3-point hitch Category I
For tractors 15 - 30 hp

Model 630 - 6' (1.8 m) cutting width, 3-point hitch Category I
For tractors 20 - 30 hp



[1] Independent axle beams. **[2]** Pneumatic tires with puncture proof sealant are standard; solid rubber tires can be equipped as an option. **[3]** All models are quick hitch compatible.



MODEL	430	530	630
Cutting width	48"	60"	72"
Cutting height	1-1/2" to 5-1/2"	1-1/2" to 5-1/2"	1-1/2" to 5-1/2"
Blade tip speed	15,485 ft/min	15,829 ft/min	18,737 ft/min
Blades	3	3	3
Blade material	1/4" x 2-1/4"	1/4" x 2-1/4"	1/4" x 2-1/4"
Blade length	17-3/4"	21-3/4"	25-3/4"
Blade overlap	1-5/8"	2-5/8"	2-5/8"
Blade drive	2 belt B groove	2 belt B groove	2 belt B groove
Deck material	10 gauge	7 gauge	7 gauge
Gearbox	Closed (540 RPM)	Closed (540 RPM)	Closed (540 RPM)
Gearbox ratio	1 : 1.93	1 : 1.93	1 : 1.93
Tractor requirement	12 - 25 hp	15 - 30 hp	20 - 30 hp
3-point hitch	Category I	Category I	Category I
Tires	4.10 / 3.50 - 4	4.10 / 3.50 - 4	4.10 / 3.50 - 4
Spindles	Cast iron, sealed	Cast iron, sealed	Cast iron, sealed
Front roller	4" x 5-3/8"	4" x 5-3/8"	4" x 5-3/8"
Weight, approx.	442 lb	503 lb	569 lb

FINISHING MOWER



HEAVY-DUTY MODELS 555 // 655 // 755

PRODUCT OVERVIEW

- Built for mowing parks, lawns and sports fields
- Category I
- 15 to 55 hp required

FEATURES

- Spring-loaded, self-tensioning belt adjustment
- Two gates hi-power, raw edge, rubber V-belts
- Independent axle beams
- Quick hitch compatible

OPTIONS

- Solid rubber tires
- Rear safety chain

AVAILABLE COLORS



*Red is the standard color.

THE FARM KING HD FINISHING MOWER SERIES WAS DESIGNED TO HANDLE THE TOUGHEST JOBS AND IS CAPABLE OF PROVIDING A CLEAN, GROOMED FINISH ON ROUGH, UNEVEN TERRAIN.

Manufactured with top quality material, the mower deck features solid reinforcing plates which are found beneath the deck at all spindle and axle mounting locations. Additionally the hard-surfaced blades and heavy-duty spindles prepare the Farm King Finishing Mower for any job.

These finishing mowers are Quick Hitch compatible and are available in widths ranging from 60" to 84".

HARD SURFACED BLADES

Each mower features three high-speed blades with one of the highest rated tip-speeds in the industry. This creates powerful suction that lifts the grass for a crisp cut. A blade overlap of 1-5/8" to 2-5/8" prevents stripping and ensures the lawn is mowed evenly.





Model 555 - 5' (1.5 m) cutting width, 3-point hitch Category I
For tractors 15 - 55 hp

Model 655 - 6' (1.8 m) cutting width, 3-point hitch Category I
For tractors 20 - 55 hp

Model 755 - 7' (2.1 m) cutting width, 3-point hitch Category I
For tractors 25 - 55 hp



[1] Independent axle beams. **[2]** An optional chain kit minimizes the possibility of flying debris. **[3]** Two gates, hi-power, raw edge, rubber V-belts with spring loaded idler. **[4]** Steel gearbox cover.



MODEL	555	655	755
Cutting width	60"	72"	84"
Cutting height	1-1/2" to 5-1/2"	1-1/2" to 5-1/2"	1-1/2" to 5-1/2"
Blade tip speed	15,829 ft/min	18,737 ft/min	18,552 ft/min
Blades	3	3	3
Blade material	1/4" x 2-1/4", Hard surfacing	1/4" x 2-1/4", Hard surfacing	1/4" x 2-1/4", Hard surfacing
Blade length	21-3/4"	25-3/4"	29-3/4"
Blade overlap	2-5/8"	2-5/8"	2-5/8"
Blade drive	2-rubber	2-rubber	2-rubber
Deck material	7 gauge	7 gauge	7 gauge
Gearbox	Closed (540 RPM)	Closed (540 RPM)	Closed (540 RPM)
Gearbox ratio	1 : 1.93	1 : 1.93	1 : 1.93
Tractor requirement	15 - 55 hp	20 - 55 hp	25 - 55 hp
3-point hitch	Category I	Category I	Category I
Tires	13 / 500 x 6 4-ply	13 / 500 x 6 4-ply	13 / 500 x 6 4-ply
Spindles	Cast iron, sealed	Cast iron, sealed	Cast iron, sealed
Front roller	4" x 6-15/16"	4" x 6-15/16"	4" x 6-15/16"
Weight, approx.	627 lb	697 lb	780 lb

FLEX-WING ROTARY CUTTER



MODEL 1530

PRODUCT OVERVIEW

- Built to clear rough areas where stones, tree stumps and debris are hidden by weeds
- Double swivel clevis hitch
- 65 hp required

FEATURES

- Independent wheel assembly suspension
- One of the fastest blade tip speeds in the industry, up to 16,737 ft/min (5101 m/min)
- Heat-treated blades
- Deck protection ring / Stump jumper
- Chain kit
- Transport lock / Safety chain

OPTIONS

- Double axle
- Light kit
- Laminated or aircraft tires

AVAILABLE COLORS



*Red is the standard color.

THE NEW FARM KING 1530 ROTARY CUTTER IS DESIGNED FOR THE TOUGHEST CUTTING JOBS IN HEAVY, THICK GRASS AND WEEDS.

With a class-leading 7" blade overlap for a thorough cut and a working range of +/- 25°, this machine is ideal for cutting deep grassy ditches and trenches.

DECKS

The decks on this heavy-duty cutter, designed by Farm King from the ground up, are manufactured using 7 gauge steel. A deck protection ring minimizes stress on the deck while the stump jumper protects the mower deck and allows the assembly to glide over uneven terrain. The streamline deck design maintains strength and prevents buildup. Standard equipment such as a single chain guard attached to the entire deck limits the possibility of flying debris.

SUSPENSION

The suspension on the Farm King 1530 individually isolates each wheel assembly from the machine, reducing road vibration and terrain roughness. This provides a smoother ride and reduces shock stress on the frame, axle and driveline.

CUTTING WIDTH & TRANSPORT

The Farm King 1530 features an 186" cutting width in the working position and folds to only 96" for transport.



5 YEAR LIMITED GEARBOX WARRANTY

HEAT-TREATED BLADES

Each blade is heat-treated to enhance rigidity, while the heavy-duty gearbox is designed to be rugged and durable. The access panel located on the deck makes it easy to inspect, clean or replace the blades if necessary. The blades also have an industry-leading 7" overlap to make sure you get the best cut the first time.

OPTIONAL EQUIPMENT

Several options are available to enhance the Farm King 1530 to properly suit the needs of your land including light kits, double axle and either laminated or aircraft tires.

GEARBOX WARRANTY

Farm King offers a five year limited gearbox warranty.

[1] Decks are manufactured using 7 gauge steel **[2]** The suspension individually isolates each wheel assembly from the machine, reducing road vibration and terrain roughness **[3]** Heat-treated blades for enhanced rigidity **[4]** 96" transport width



MODEL	1530	
Manufacturing	Heavy-duty / Commercial	
Width, working / overall	186 in (4.7 m) / 194 in (4.9 m)	
Transport, width / height	96 in (2.4 m) / 92 in (2.3 m)	
Working range	+/- 25°	
Cutting height	2 to 15 in (51 to 381 mm)	
Weight	5900 lb (2676 kg)	
Tongue weight	2100 lb (953 kg)	
Tractor hp requirement, min.	65 hp	
Gearbox hp: splitter / wings	250 hp / 190 hp	
Gearbox speed	540 RPM	1000 RPM
Wing blade tip speed	16,481 ft/min (5023 m/min)	16,737 ft/min (5101 m/min)
Center blade tip speed	16,197 ft/min (4937 m/min)	15,802 ft/min (4816 m/min)
Blade overlap	7 in (177 mm)	
Blade	0.5 x 4, Uplift	
Stump jumper	Symmetric die pressed (7 Ga.)	
Deck material thickness	0.179 in (7 Ga) (4.5 mm)	
Side skirt thickness	0.25 in (6.4 mm)	
Side skid	Reversible and replaceable	
Suspension	Independent rubber-isolated wheel assemblies	
Hitch	Double swivel clevis hitch	
Tires	(6 in or 8 in.): 24 x 7.7 x 10 aircraft tires (air filled) or 21 in. laminated wheels (solid rubber)	

ROTARY CUTTER



SERIES I // II

PRODUCT OVERVIEW

- Built to clear rough areas where stones, tree stumps and debris are hidden by weeds
- Category I & II
- 20 - 75 hp required

FEATURES

- The stump-jumper is standard on Series II
- 15" laminated 3-point or 16" solid rubber tire

OPTIONS

- Chain Kit
- Trailing kit with optional hydraulic lift
- Parking Jack (series II)

AVAILABLE COLORS



*Red is the standard color.



FARM KING ROTARY CUTTERS ARE MADE TO CLEAR THOSE ROUGH AREAS WHERE STONES, TREE STUMPS AND DEBRIS ARE HIDDEN BY WEEDS.

These rotary cutters, available in two series, easily clear heavy weeds and thick rough and require minimal maintenance. Series I, with a 3-point hitch, is available in 48" or 60" widths. Series II is available in widths of 60", 72" and 84". Two available options include a trailing kit with hydraulic lift or a 3-point hitch.

STUMP JUMPER

A 24" stump-jumper is mounted above the blades to the gearbox. Standard on Series II, the stump-jumper allows the blade assembly to glide over uneven terrain.

FEATURES

- » The power take-off (PTO) shaft on the Series II 60" includes a shear pin to protect the gearbox in the event of an unforeseen obstacle.
- » 3-point hitch models include a single solid rubber or laminated trailing wheel.
- » The access panel on the deck makes it easy to replace the blades.
- » The 72" and 84" rotary cutters are equipped with a slip clutch to prevent gearbox damage.
- » An optional chain kit minimizes the possibility of flying debris.



SERIES I

Model 410 - 48" (1.2 m) cutting width, 3-pt hitch Cat. I
For tractors 20 - 45 hp

Model 510 - 60" (1.5 m) cutting width, 3-pt hitch Cat. I
For tractors 25 - 55 hp

SERIES II

Model 510 - 60" (1.5 m) cutting width, 3-pt hitch Cat. I
For tractors 25 - 65 hp

Model 620 - 72" (1.8 m) cutting width, 3-pt hitch Cat. II
For tractors 35 - 65 hp

Model 720 - 84" (2.1 m) cutting width, 3-pt hitch Cat. II
For tractors 45 - 75 hp

[1] An optional chain kit minimizes the possibility of flying debris. **[2]** 3-point hitch models include a single solid rubber or laminated trailing wheel. **[3]** The stump-jumper helps to minimize stress on the deck and gearbox.



SERIES	I		II		
MODEL	410	510	510	620	720
Cutting width	48"	60"	60"	72"	84"
Cutting height	Minimum 3"	Minimum 4"	Minimum 4"	Minimum 4"	Minimum 4"
Blade tip speed	13,098 ft/min	12,721 ft/min	12,721 ft/min	14,758 ft/min	14,283 ft/min
Spring steel blades	1/2" x 3" heat treated	1/2" x 3" heat treated	1/2" x 3" heat treated	1/2" x 3" heat treated	1/2" x 3" heat treated
Deck material	11 gauge	11 gauge	10 gauge	10 gauge	10 gauge
Gearbox	Closed (540 RPM)	Closed (540 RPM)	Closed (540 RPM)	Closed (540 RPM)	Closed (540 RPM)
Gearbox rating	30 hp	40 hp	40 hp	60 hp	65 hp
Tractor requirement	20 - 45 hp	25 - 55 hp	25 - 65 hp	35 - 65 hp	45 - 75 hp
PTO shaft	Shear pin	Shear pin	Shear pin	Slip clutch	Slip clutch
3-point hitch*	Category I	Category I	Category I	Category II	Category II
Tire - 3-point	15" laminated	15" laminated	16" solid rubber	16" solid rubber	20" solid rubber
Tire / wheels - trailing	N/A	N/A	Solid rubber or 15" rim	Solid rubber or 15" rim	15" rim
Stump-jumper	N/A	N/A	24" diameter	24" diameter	24" diameter
Parking jack	N/A	N/A	Optional	Optional	Optional
Chain kit	Optional	Optional	Optional	Optional	Optional
Weight - 3-point	450 lb	520 lb	601 lb	777 lb	989 lb
Weight - trailing	N/A	N/A	686 lb	856 lb	1080 lb

ROTARY TILLER



SERIES 25 // 45 // 65

PRODUCT OVERVIEW

- Built for landscaping gardens, orchards, nurseries, hobby farms and homesteads
- Category I, opt. fit Category II
- 12 - 65 hp required

FEATURES

- Slip clutch
- Automatic chain tightener enhances longevity
- Sideshift, series 45 and model 6572

OPTIONS

- 4 tines per flange on 65 Series (6 standard)

AVAILABLE COLORS



*Red is the standard color.



FARM KING HAS A COLLECTION OF ROTARY TILLER MODELS TO SUIT YOUR GARDEN AND LANDSCAPING NEEDS.

The tiller attaches to the three-point hitch and is designed to fit a variety of tractors, from 12 hp to 65 hp. Tilling widths range from 36" to 54" in the 25 Series and from 55" to 69" in the 45 Series. The 65 Series is available in 68" and 77" widths.

SIDESHIFT

Getting close to fences, hedges or covering a tire track is easy with the sideshift feature. The entire unit can be pushed to one side while the PTO shaft remains in line with the tractor to minimize stress on the universal joint.

FEATURES

- » The rotator tilling shaft is equipped with four to eight flanges, depending on the model.
- » Flanges on all series are available with four tines, and six tines per flange are standard on the 65 Series.
- » Housed in a sealed oil bath, the chain tightener assembly is resistant to heat, dust, debris and moisture, which reduces maintenance and enhances the longevity of the chain and sprockets.
- » Farm King Rotary Tillers come standard with a parking jack and height adjustable skid shoes.

SERIES 25

Model TL236 - 36" (0.9 m) tillage width, 3-point hitch Category I
For tractors 20 - 45 hp

Model TL245 - 45" (1.1 m) tillage width, 3-point hitch Category I
For tractors 25 - 55 hp

Model TL254 - 54" (1.4 m) tillage width, 3-point hitch Category I
For tractors 25 - 55 hp

SERIES 45

Model 4560 - 55" (1.4 m) tillage width, 3-point hitch Category I
For tractors 25 - 65 hp

Model 4572 - 69" (1.8 m) tillage width, 3-point hitch Category I
For tractors 35 - 65 hp

SERIES 65

Model 6572 - 68" (1.7 m) tillage width, 3-point hitch Category I / II For
tractors 25 - 65 hp

Model 6582 - 77" (2.0 m) tillage width, 3-point hitch Category I / II
For tractors 35 - 65 hp



[1] The sideshift feature is available on the 45 Series and model 6572. **[2]** Flanges on all series are available with four tines. Six tines per flange are standard on the 65 Series. **[3]** Housed in a sealed oil bath, the chain tightener assembly is resistant to heat, dust, debris and moisture, which reduces maintenance and enhances the longevity of the chain and sprockets.

SERIES	25			45		65	
MODELS	236	245	254	4560	4572	6572	6582
Tillage width	36"	45"	54"	55"	69"	68"	77"
Overall width	46-1/2"	54-1/2"	66-1/2"	66"	78"	78"	88"
Tractor requirement	12 - 18 hp	14 - 22 hp	18 - 25 hp	25 - 40 hp	30 - 45 hp	45 - 55 hp	55 - 65 hp
3-point hitch	Cat. I	Cat. I	Cat. I	Cat. I	Cat. I	Cat. I, opt. fit Cat. II	Cat. I, opt. fit Cat. II
Gearbox	Heavy-duty oil bath (540 RPM)	Heavy-duty oil bath (540 RPM)	Heavy-duty oil bath (540 RPM)	Heavy-duty oil bath (540 RPM)	Heavy-duty oil bath (540 RPM)	Heavy-duty oil bath (540 RPM)	Heavy-duty oil bath (540 RPM)
Chain in oil bath	#80H	#80H	#80H	#80H	#80H	#100H	#100H
Rotor speed RPM	239 RPM	239 RPM	239 RPM	203 RPM or 865 ft/min	203 RPM or 865 ft/min	196 RPM or 880 ft/min	196 RPM or 880 ft/min
Sideshift	n/a	n/a	n/a	6-3/4"	8-1/2"	15"	n/a
PTO shaft	Slip clutch	Slip clutch,	Slip clutch	Slip clutch	Slip clutch	Slip clutch	Slip clutch
Tine size	1/4" x 2-1/4"	1/4" x 2-1/4"	1/4" x 2-1/4"	1/4" x 2-1/4"	1/4" x 2-1/4"	5/16" x 3-1/4"	5/16" x 3-1/4"
No. of tines/No. of flange	16/4	20/5	24/6	24/6	32/8	42/7 (opt. 28/4)	48/8 (opt. 32/4)
No. of tines per flange	4	4	4	4	4	6 (opt. 4)	6 (opt. 4)
Skid shoes	Standard	Standard	Standard	Standard	Standard	Standard	Standard
Weight	385 lb	418 lb	477 lb	613 lb	688 lb	906 lb	968 lb

*Red is the standard color.

BOX SCRAPER



AVAILABLE IN:



MODELS 483 // 604 // 725 // 846

PRODUCT OVERVIEW

- Built for landscaping, snow removal, construction
- Category I
- 20 - 65 hp required

FEATURES

- Two 1/2" x 6" replaceable blades
- Heat treated scarifier shanks

TWO 1/2" X 6" REPLACEABLE, BACK TO BACK BLADES MAKE THIS BI-DIRECTIONAL SCRAPER EXTREMELY VERSATILE.

The scarifier shanks are heat treated and are easily adjusted for depth. The Farm King Box Scraper features a replaceable / reversible back to back cutting edge as well as replaceable / reversible scarifier shanks for forward and reverse use.

[1] The 1/2" x 6" cutting edges on the Farm King Box Scraper are reversible and replaceable.

[2] 4-position scarifier shanks provides a variety of digging depths of up to 4".



MODEL	483	604	725	846
Width	48"	60"	72"	84"
Capacity (approximate)	6 cu. ft.	8 cu. ft.	10 cu. ft.	12 cu. ft.
Max. working depth	4"	4"	4"	4"
Reversible cutting edge	1/2" x 6" replaceable	1/2" x 6" replaceable	1/2" x 6" replaceable	1/2" x 6" replaceable
No. of cutting edges	2	2	2	2
Reversible shanks	3/4" x 2-3/8" replaceable	3/4" x 2-3/8" replaceable	3/4" x 2-3/8" replaceable	3/4" x 2-3/8" replaceable
No. of shanks	3	4	5	6
Shank tip width	1-1/2"	1"	1"	1"
3-point hitch	Category I	Category I	Category I	Category I
Tractor requirements	20 - 40 hp	20 - 45 hp	25 - 55 hp	30 - 65 hp
Weight	320 lb	378 lb	428 lb	469 lb

*Red is the standard color.

LANDSCAPING RAKE



AVAILABLE IN:



MODELS 6030 // 7236 // 8442 // 9648

PRODUCT OVERVIEW

- Built to spread and level soil, gravel, beaches and seed beds
- Category I
- 20 - 65 hp required

FEATURES

- 5/16" x 1" spring-steel tines
- Reversible for push or pull applications

OPTIONS

- Gauge wheels

THE FARM KING LANDSCAPE RAKE IS IDEAL FOR SEEDBED PREPARATION AND TRASH REMOVAL FROM LONG GRASS, DIRT AND GRAVEL.

Five-position angle adjustment allows the operator to evenly distribute crushed rock or clumped soil. 5', 6', 7' and 8' models are available with quick hitch compatibility. Tines are evenly spaced 1" apart. Use to clear off unwanted material. Ideal for spreading and leveling crushed stone and other landscaping materials and can be used to maintain beaches and recreational areas.

[1] Optional gauge wheels provide added stability and depth control. **[2]** 1-inch wide, spring-steel tines clear off unwanted material and prepare an ideal seedbed ready to accept small seeds or sod.

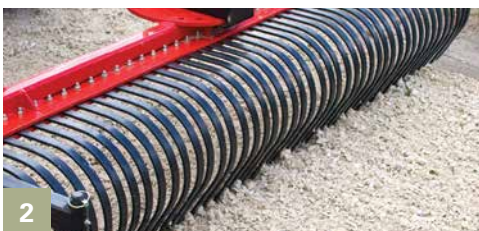

MODEL	6030	7236	8442	9648
Width	60"	72"	84"	96"
Tines	5/16" x 1" spring-steel	5/16" x 1" spring-steel	5/16" x 1" spring-steel	5/16" x 1" spring-steel
Gauge wheels	Optional	Optional	Optional	Optional
Wheel material	Solid rubber tire	Solid rubber tire	Solid rubber tire	Solid rubber tire
Angle adjustment, forward	3-position	3-position	3-position	3-position
Angle adjustment, reverse	2-position	2-position	2-position	2-position
Angle increments	20°	20°	20°	20°
3-point hitch	Category I	Category I	Category I	Category I
Parking stand	Standard	Standard	Standard	Standard
Tractor requirements	20 - 40 hp	20 - 45 hp	25 - 55 hp	30 - 65 hp
Weight	134 lb	187 lb	199 lb	331 lb

*Red is the standard color.

DRAG HARROW



AVAILABLE IN:



MODELS 80 // 1002 // 1003

PRODUCT OVERVIEW

- Ideal for freshening horse paddocks and pastures
- Category I
- 18 - 65 hp required

FEATURES

- 80" and 100" bars accept any combination of 40" and 60" harrow sections.
- Maximum ground coverage of 10'
- Heavy-duty chains provide an even pull and can be adjusted for height.

TWO AVAILABLE SIZES OF HARROW IN 40" AND 60" MAKE ANY LARGE JOB FEEL SMALL.

This harrow is great for leveling driveways, gravel parking lots, weeding out tilled soil and removing embedded trash from gravel and soils. The stirring motion of the harrow prepares a top quality seed bed for grass, saplings and other various foliage. Reinforced adjustable chain clamps make the harrow easy to adjust for desired soil penetration and better ground clearance during transportation.

[1] The rigid construction allows for the filling of potholes while the floating assembly follows the contour of the ground. **[2]** The chain height can be adjusted to the desired depth.



1



2

MODEL	80	1002	1003
Width	80"	100"	120"
Frame tubing	4" x 4"	4" x 4"	4" x 4"
Harrow sections	2 - 40"	40" and 60"	3 - 40"
Teeth	5/8"	5/8"	5/8"
Chain height	Adjustable	Adjustable	Adjustable
3-point hitch	Category I	Category I	Category I
Tractor requirements	18 - 50 hp	20 - 65 hp	20 - 65 hp
Weight	308 lb	361 lb	413 lb

*Red is the standard color.

DISC



AVAILABLE IN:



MODELS 505 // 605 // 705 // 805

PRODUCT OVERVIEW

- Built for landscaping, nurseries and homesteads
- Category I
- 20 - 65 hp required

FEATURES

- 2" x 3" x 1/4" wall tubing
- Gangs can be positioned at five different angles

OPTIONS

- Scraper kit
- Center sweep

FARM KINGS DISCS ARE HEAVILY CONSTRUCTED TO PROVIDE LONG LASTING EQUIPMENT FOR MULTIPLE APPLICATIONS.

Specializing in seedbed preparation, the Farm King disc penetrates the crusty, hard packed soil and rejuvenates it for easy seed application. Hardened steel discs help churn the soil to reveal a nutrient rich layer and deeper rich soil texture. Notched and smooth blades are available in any combination. Each Farm King disc is Quick hitch compatible.

[1] The optional scraper kit keeps discs free of clinging soil. **[2]** The optional center sweep prevents the buildup of material between the gangs.



1



2

MODEL	505	605	705	805
Width	5-1/2'	6-1/2'	7-1/2'	8-1/2'
Frame	2" x 3" x 1/4" wall tube	2" x 3" x 1/4" wall tube	2" x 3" x 1/4" wall tube	2" x 3" x 1/4" wall tube
Discs	16	20	24	28
Disc diameter	18"	18"	20"	20"
Disc spacing	7-1/2"	7-1/2"	7-1/2"	7-1/2"
Scraper kit	Optional	Optional	Optional	Optional
Center sweep	Optional	Optional	Optional	Optional
3-point hitch	Category I	Category I	Category I	Category I
HP requirements	20 - 40 hp	25 - 50 hp	30 - 60 hp	30 - 65 hp
Weight	649 lb	732 lb	899 lb	1084 lb

*Red is the standard color.

CULTIVATOR



AVAILABLE IN:



MODELS 609 // 7211 // 8413

PRODUCT OVERVIEW

- Built for nurseries, seedbed preparation and soil aeration
- Category I
- 15 - 40 hp required

FEATURES

- 2" x 2" x .250" wall tubing
- Tine point are reversible and replaceable.

OPTIONS

- Optional gauge wheels and 7" sweeps

SUPERIOR SOIL PENETRATION IS WHAT YOU WILL GET EVERY PASS WITH THE FARM KING CULTIVATOR.

This cultivator is design to give the operator optimal depth control and even soil distribution. Heavy-duty gauge wheels and a rigid design allow the cultivator to remain stable when digging deep into the soil. The shanks are easily adjustable with the help of a single bolt space adjustment clamp. Proper shank spacing allows for uniform soil distribution and minimal nutrient loss. Category I 3-point hitch; all models are Quick Hitch compatible and features single bolt spacing adjustment.

[1] Attached to solid 2" x 2" frame are forged steel S tines. The tine tips are outfitted with hardened steel reversible points. **[2]** All models are quick hitch compatible.



MODEL	609	7211	8413
Width	60"	72"	84"
Frame	2" x 2" x .250 wall tubing	2" x 2" x .250 wall tubing	2" x 2" x .250 wall tubing
Tines	Forged steel w/reversible points	Forged steel w/reversible points	Forged steel w/reversible points
Number of "S" tines	9	11	13
Gauge wheels	Optional	Optional	Optional
7" sweeps	Optional	Optional	Optional
3-point hitch	Category I	Category I	Category I
Tractor requirements	15 - 30 hp	20 - 35 hp	20 - 40 hp
Weight	190 lb	215 lb	243 lb

*Red is the standard color.

POST-HOLE DIGGER



AVAILABLE IN:



MODELS 150 // 160 // 205 // 210

PRODUCT OVERVIEW

- Shear-bolt protected and shielded PTO driveline
- Category 0, I, II
- 14 hp and greater required

FEATURES

- 3-position boom adjustment on models 150, 160, 205
- Heavy-duty tubular steel stock on the yoke and booms of all PTO-driven units

OPTIONS

- Optional down force kit for 350-500 lb extra pressure when digging conditions get tough

THE FARM KING POST HOLE DIGGER USES AN IMPRESSIVE ONE OR TWO FLIGHTING DESIGN TO DIG DEEP INTO THE HARDEST COMPACT SOIL IN ANY REGION.

Each model also comes with a five year limited warranty on most gearbox components. The auger and PTO assembly are held together using heavy-duty tubular steel stock that allows the post hole digger to remain stable under the most grueling conditions. Simply attach the post-hole digger to any three point hitch assembly or skid steer mount, hook up hydraulic lines and the digger is ready for use.

[1] Choose from 6" to 30", single and double flighted augers with optional 12" auger extensions (with guards) and special fishtail auger center points.



MODEL	150	160	205	210
Main frame (O.D. size of steel tubing)	-	3"	3-1/2"	3-1/2"
Gear ratio	3:1	3:1	3.18:1	4.1:1
Boom positions	3	3	3	1
Hitch size	Cat. 0	Cat. I/II	Cat. I/II	Cat. I/II
Down force kit	Optional	Optional	Optional	Optional
Output shaft	2"	2"	2"	2"
Weight	149 lb	160 lb	206 lb	210 lb

*Red is the standard color.

POST DRIVER



MODELS 1450 // 2400

PRODUCT OVERVIEW

- Built for fast, easy fence post installation
- Category I and II
- 100,000 lb at full impact

FEATURES

- Self-contained hydraulic system
- Full hydraulic controls
- Welded, tubular steel construction

OPTIONS

- Post guide
- Hydraulic extendable hitch (model 2400)

THE FARM KING 3-POINT POST DRIVER WORKS WITH YOUR TRACTOR OR SKID-STEER FOR EFFICIENT EFFORTLESS POST DRIVING.

Built to be fast, powerful, durable, and maneuverable, Farm King 3-point post drivers are ideal for use on the jobsite or on the farm.

Farm King 2400 trailed post drivers makes work easy. Available in a PTO or 9 hp engine models, Farm King post driver trailers can work with a tractor or behind a pick-up truck. Designed to be maneuverable and durable Farm King post drivers are perfect for farmers, ranchers, and contractors.



HAMMER

A large 9" x 14" hammer face is wider for easier lining up and deeper for pounding on the opposite side of the wire. This eliminates the need to drive around existing fence line. Hammer Mast - A 12" wide welded track provides for smooth guided hammer operation. No internal pads or shims to adjust or maintain. A 62" cylinder stroke, combined with a 1-5/8" diameter cylinder bore, ensures a fast acting downward force.

MODEL 2400 - ENGINE AND PTO DRIVE

[1] A sturdy in / out slide mechanism that allows 0–16" of movement for ease of adjustment to fence line. A heavy-duty cross axle tube reinforces both wheel legs and undercarriage. A large in frame weight box allows required ballasting of the post driver for stable operation.

[2] The Engine driven model is equipped with a 9 hp gasoline engine and utilizes a direct mounted hydraulic pump which eliminates the need for belts or pulleys.

HYDRAULIC CONTROLS

[3] Fingertip hydraulic controls are standard and allows for smooth 4-way tilt, in/out slide and hammer up/down.

DRIVE

[4] Self-contained hydraulics eliminates possible oil contamination between power unit and post driver. All models are equipped with oversized hydraulic pumps which allows full operation at reduced rpm.



MODEL 1450 - 3-POINT HITCH

STANDARD EQUIPMENT

- Category I and II 3-point hitch
- Optional skid steer Quick-Tach mount frame
- Integral stand
- PTO driven hydraulic pump
- Self-contained hydraulic system
- Full hydraulic controls

3-PT BASE

- 6" x 8" base pads, wide stance for stability
- Welded, tubular steel construction
- Category II bushings included

MODEL 1450 - SKID STEER

SKID STEER

Skid Steer Quick-Tach Mount Frame*

- 45" wide, 235 lb (107 kg)
- Includes hydraulic drive motor with couplers

*skid steer must be equipped with Quick-Tach carrier

OPTIONAL EQUIPMENT

- Post guide

MODEL 2400 - ENGINE AND PTO DRIVE

STANDARD EQUIPMENT

- PTO or engine driven hydraulic pump
- Self-contained hydraulic system
- Full hydraulic controls
- Large hammer face
- Hammer ballast box with lid
- Welded frame, axle and counter weight box reduces set up time
- Rear stand to prevent backward flip over

OPTIONAL EQUIPMENT

- Mast extension
- Hydraulic extendable hitch
- 2" ball hitch receiver

MODEL	1450 - 3-Point Hitch and Skid Steer
Frame	All welded tubular steel construction
Assembly	Cat. I or II 3-pt hitch or opt. skid steer mount
Mast	12" (305 mm) wide track
Hammer weight	310 lb (141 kg)
Impact at full stroke	100,000 lb (45,360 kg)
Hydraulic requirements	6-8 gpm @ 300-500 rpm (22.7-30.3 lpm @ 300-500 rpm)
Maximum hammer height	Standard lift 105" (2.67 m)
Minimum hammer height	43" (1090 mm)
Maximum hammer stroke	62" (1570 mm)
Leveling adjustment	2" x 8" cylinder on mast (1) 2" x 8" cylinder on hammer pivot (1)
Angle of tilt, from vertical	Front / Back: Fore 15° / Aft 35° Side tilt: Left 22° / Right 22°
Hydraulic pump	12 gpm @ rated speed
Basic shipping weight	1135 lb (515 kg)

MODEL	2400 - Engine or PTO Drive
Frame	All welded tubular steel construction
In frame counterweight box	15" x 15" x 25" – 3.2 cu. ft. (92L)
Wheel track width	69" (1750 mm)
Wheel rims	15" (381 mm) (6.70 x 15 4-ply bias tires optional)
Wheel bearings	Tapered roller
Mast	12" (305 mm) wide track
Hammer weight	310 lb (141 kg) empty, up to 700 lb (318 kg) ballasted
Impact at full stroke	100,000 lb (45,360 kg)*
Maximum hammer height	Standard lift 105" (2.67 m), 128" (3.25 m) with optional mast extension
Minimum hammer height	43" (1090 mm), 66" (1676 mm) with optional mast extension
Maximum hammer stroke	62" (1570 mm)
In & out hammer slide	16" (410 mm)
Hammer tilt, from vertical	Fore 20° / Aft 15°, Side Tilt: Left 40° / Right 22°
Basic shipping weight	PTO: 1190 lb (540 kg), Engine: 1300 lb (590 kg)

*Impact lb are based on an 8" diameter post driven into packed clay soil with non ballasted hammer. Impact increases proportionally with ballast in hammer.

REAR BLADE



SERIES 30 // 45 // 60 // 80 // 100 // 155

PRODUCT OVERVIEW

- Constructed for ditching, scraping, landscaping and snow removal applications
- Category I, II, III
- 15 - 150 hp required

FEATURES

- Reversible and replaceable cutting edge
- No tools are required for adjusting the angle
- Pivot Pin designed with tight tolerances

OPTIONS

- Hydraulic angle adjustment, Series 60

FARM KING HAS BEEN BUILDING A WIDE VARIETY OF REAR BLADES FOR SEVERAL DECADES.

These blades are manufactured using more steel, which adds strength, longevity and durability to each blade. Available in five series suitable for tractors ranging from 15 hp to 150 hp, Farm King Rear Blades are capable of tackling tough scraping projects.

PIVOT POINT

These rear blades have been precisely built, with particular attention to the pivot point. To minimize metal-on-metal wear and maximize blade longevity, the pivot point has been designed with tight tolerance and built to those specifications.

TILT ADJUSTMENT

The manual tilt adjustment on the 45 Series tilts the blade up to 15°. The same bolts adjust the sideshift feature to move the blade up to 12" off-center. Adjusting the angle on models without hydraulic cylinders does not require tools.

FEATURES

Standard equipment includes parking stand and 3-point hitch compatibility.





Series 30 - 3-point hitch Category I

Widths: Model 3048 - 4' / Model 3060 - 5' / Model 3072 - 6'
For tractors up to 30 hp

Series 45 - 3-point hitch Category I

Widths: Model 4560 - 5' / Model 4572 - 6' / Model 4584 - 7'
For tractors up to 45 hp

Series 60 - 3-point hitch Category I

Widths: Model 6084 - 7' / Model 6096 - 8'
For tractors up to 60 hp

Series 80 - 3-point hitch Category I

Widths: Model 8084 - 7' / Model 8096 - 8' / Model 80108 - 9'
For tractors up to 80 hp

Series 100 - 3-point hitch Category II

Widths: Model 10096 - 8' / Model 100108 - 9'
For tractors up to 100 hp

Series 155 - 3-point hitch Category I

Widths: 15596 - 8' / 155108 - 9' / 155120 - 10' / 155144 - 12'
For tractors up to 150 hp

[1] The sideshift feature moves the blade up to 12" off-center. [2] Adjusting the angle on models without hydraulic cylinders does not require tools. [3] The manual tilt adjustment on the 45 Series tilts the blade up to 15°.



SERIES	30			45			60		80			100		155			
	MODEL	3048	3060	3072	4560	4572	4584	6084	6096	8084	8096	80108	10096	100108	15596	155108	155120
Maximum hp	30 hp (22 kW)			45 hp (34 kW)			60 hp (45 kW)		80 hp (60 kW)			100 hp (75 kW)		150 hp (112 kW)			
3-point hitch	Cat. I			Cat. I			Cat. I/II		Cat. II			Cat. II/III		Cat. II/III			
Moldboard thickness - Box reinforcement	1/4" (6 mm)			1/4" (6 mm)			1/4" (6 mm)		1/4" (6 mm)			5/16" (8 mm) Yes		5/16" (8 mm) Yes			
Moldboard width	48" (1.2 m)	60" (1.5 m)	72" (1.8 m)	60" (1.5 m)	72" (1.8 m)	84" (2.1 m)	84" (2.1 m)	96" (2.4 m)	84" (2.1 m)	96" (2.4 m)	108" (2.7 m)	96" (2.4 m)	108" (2.7 m)	96" (2.4 m)	108" (2.7 m)	120" (3.0 m)	144" (3.7 m)
Moldboard height	12-1/2" (32 cm)			13" (33 cm)			16" (41 cm)		18" (46 cm)			18" (46 cm)		21-1/4" 18" (54 cm)			
Adjustment	Manual 5-pos.			Manual 5-pos.			Manual 5-pos.		Manual or hyd.			Manual or hyd.		Manual or hyd.			
Adjustment, angle	30° left or right			40° left or right			40° left or right		30° left or right			30° left or right		30° left or right			
Adjustment, hydraulic cylinder adjustment	N/A			N/A			Optional		N/A			N/A		N/A			
Adjustment, tilt	3-point hitch linkage adj.			Manual 15° blade adjustment			3-point hitch linkage adj.		Manual or hyd. 13° blade adj.			Manual or hyd. 13° blade adj.		Manual or hyd. 13° blade adj.			
Offset	N/A			N/A			N/A		Manual or hyd. 20° left or right			Manual or hyd. 20° left or right		Manual or hyd. 20° left or right			
Sideshift	N/A			Up to 12" (30 cm) off center			N/A		N/A			N/A		N/A			
King pin	N/A			N/A			N/A		3"			3-1/2"		4"			
Cutting edge, reversible	1/4" x 3" (6 x 76 mm)			High carbon 1/2" x 6" (12 x 152 mm)			High carbon 1/2" x 6" (12 x 152 mm)		High carbon 1/2" x 6" (12 x 152 mm)			High carbon 1/2" x 6" (12 x 152 mm)		High carbon 1/2" x 6" (12 x 152 mm)			
Weight	130 lb (59 kg)	155 lb (70 kg)	180 lb (82 kg)	263 lb (119 kg)	283 lb (128 kg)	289 lb (131 kg)	405 lb (184 kg)	450 lb (204 kg)	939 lb (426 kg)	969 lb (440 kg)	989 lb (449 kg)	1287 lb (584 kg)	1352 lb (613 kg)	1683 lb (763 kg)	1710 lb (776 kg)	1749 lb (793 kg)	1846 lb (837 kg)
Dual gauge wheel kit	N/A			N/A			N/A		Optional			Optional		Optional			
Skid shoes	N/A			N/A			N/A		Optional			Optional		Optional			
Racket jack	N/A			N/A			N/A		Optional			Optional		Optional			

SERIES 30



FOR TRACTORS 15-30 HP

Available in 4', 5' and 6' widths. Manual adjustment. Tilt adjustment is 3-point hitch linkage adjustment.

SERIES	30
3-point hitch	Cat. I
Angle	30° left or right
Angle - forward	5-position
Angle - reverse	5-position

SERIES 45



FOR TRACTORS 20-45 HP

Available in 5', 6' or 7' widths. 15° vertical tilt on both sides. Cutting edge constructed of high carbon steel, 1/2" x 6".

SERIES	45
3-point hitch	Cat. I
Angle	40° left or right
Angle - forward	5-position
Angle - reverse	N/A

SERIES 60



FOR TRACTORS 30-60 HP

Available in 7' and 8' widths. Mechanical linkage. Hyd. adjustment is optional. Cutting edge constructed of high carbon steel, 1/2" x 6".

SERIES	60
3-point hitch	Cat. II, I optional
Angle	40° left or right
Angle - forward	5-position
Angle - reverse	5-position

SERIES 80



FOR TRACTORS 80 HP

Available in 7', 8' and 9' widths. Angle adjustment, offset and tilt can be fitted with either hydraulic cylinders or mechanical linkage.

SERIES	80
3-point hitch	Cat. II
Angle	30° left or right
Angle - forward	5-position
Angle - reverse	5-position

SERIES 100



FOR TRACTORS 100 HP

Available in 8' and 9' widths. Hydraulic angle adjustment, offset and tilt. Cutting edge constructed of high carbon steel, 1/2" x 6".

SERIES	100
3-point hitch	Cat. II and III
Angle	30° left or right
Angle - forward	5-position
Angle - reverse	5-position

SERIES 155



FOR TRACTORS 150 HP

Available in 8', 9', 10' and 12' widths. Hydraulic angle adjustment, offset and tilt. Cutting edge constructed of high carbon steel, 1/2" x 6".

SERIES	155
3-point hitch	Cat. II and III
Angle	30° left or right
Angle - forward	5-position
Angle - reverse	5-position

QUICK HITCH



CATEGORY II // II // III // II/III

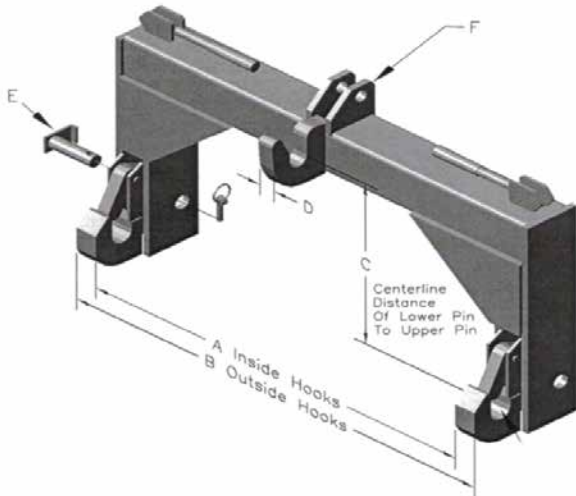

THE BEST PART ABOUT OWNING A TRACTOR IS PUTTING IT TO GOOD USE.

Regardless of the size of your tractor, a number of implements are available to maximize the usefulness of your machine. Whether you have a compact utility tractor or a large four-wheel-drive, the quick hitch can be matched to various types of mowers, tillers, rear blades, box scrapers, cultivators and rakes to turn any tractor into a multi-purpose farming tool.

MODEL	C3101	C3201	C3301	C3231
Category	I	II	III	II / III
A	27-1/4	32-3/4	38-1/4	38-1/4
B	29-1/2	36-1/4	42-3/4	42-3/4
C	14-1/2 to 17-1/4	14-7/8	18-7/8	19
D	1-1/4	1-1/4	1-1/4	1-1/4
E	7/8	1-1/8	1-7/16	1-1/8
F	3/4	1	1-1/4	1-1/4
Weight	76 lb	134 lb	182 lb	185 lb

SNOWBLOWER



COMPACT MODELS 500 // 600 // 660 // 740 // 840

PRODUCT OVERVIEW

- Rear attach for use on acreages, farms and municipalities
- Category I, II, IIIN
- 15 - 90 hp

FEATURES

- Spout rotator and deflector available as manual or hydraulic
- Standard shear bolt protection on all PTOs

OPTIONS

- Electric spout rotator (models 500, 600, 660 only)

AVAILABLE COLORS



*Red is the standard color.

FARM KING HAS BEEN BUILDING RELIABLE SNOWBLOWERS FOR MORE THAN THREE DECADES.

Through the years the design has been refined to create an excellent snowblower that is easy to use and maintain. PTO-driven Farm King compact snowblowers attach to 3-point hitch and are available in widths ranging from 50" to 84".

The Farm King snowblower features a hand crank or hydraulic spout rotator on models 500, 600 and 660. A hydraulic cylinder is standard on the spout rotation on models 740 and 840.

The spout rotator is available with manual or hydraulic positioning. Adjustable and replaceable skid shoes are standard on all models. A 4-blade fan is standard equipment on all models. Durable construction - 7 gauge auger flighting.





Model 500 - 50" (1.3 m) cutting width
For tractors 15 - 30 hp, 3-point hitch Category I

Model 600 - 60" (1.5 m) cutting width
For tractors 20 - 40 hp, 3-point hitch Category I

Model 660 - 66" (1.7 m) cutting width
For tractors 22 - 40 hp, 3-point hitch Category I

Model 740 - 74" (1.9 m) cutting width
For tractors 40 - 70 hp, 3-point hitch Category I / II

Model 840 - 84" (2.1 m) cutting width
For tractors 60 - 90 hp, 3-point hitch Category I / II / IIIN

[1] A hand crank spout rotator is standard on models 500, 600 and 660 while a hydraulic setup is standard on models 740 and 840 **[2]** Adjustable and replaceable skid shoes are standard equipment **[3]** The chain drive is easily accessible for routine maintenance **[4]** The open gear setup is easy to maintain and service.

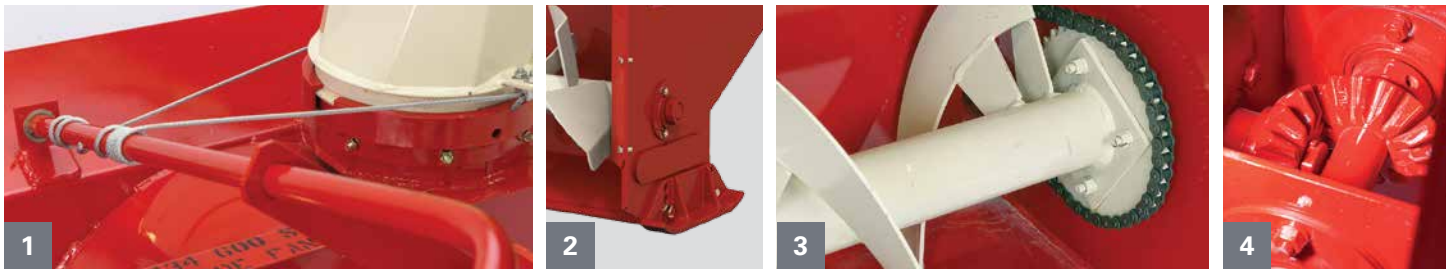

MODEL	500	600	660	740	840	840G
Cutting width	50"	60"	66"	74"	84"	84"
Cutting height	24"	24"	24"	25"	25"	25"
Replaceable cutting edge	N/A	N/A	N/A	N/A	N/A	N/A
Fan	4-blade	4-blade	4-blade	4-blade	4-blade	4-blade
Fan dimensions	22" x 7"	22" x 7"	22" x 7"	23" x 7"	23" x 7"	23" x 7"
Replaceable fan housing	N/A	N/A	N/A	N/A	N/A	N/A
Drive fan	540 RPM open gear	540 RPM open gear	540 RPM open gear	540 RPM open gear	540 RPM open gear	540 RPM oil bath gearbox
Auger diameter	15"	15"	15"	15"	15"	15"
Auger drive	#50 chain	#50 chain	#50 chain	#50 chain	#50 chain	#50 chain
Spout rotator - manual (hand crank) - hydraulic cylinder	Standard Optional	Standard Optional	Standard Optional	N/A Standard	N/A Standard	N/A Standard
Spout deflector - manual (6 position) - hydraulic cylinder	Standard Optional	Standard Optional	Standard Optional	Standard Optional	Standard Optional	Standard Optional
Skid shoes	Adjustable and replaceable	Adjustable and replaceable	Adjustable and replaceable	Adjustable and replaceable	Adjustable and replaceable	Adjustable and replaceable
Hitch category	Cat. I standard Cat. I Q.H standard	Cat. I standard Cat. I Q.H standard	Cat. I standard Cat. I Q.H standard	Cat. I standard Cat. II bushings	Cat. I & II std Cat. II Q.H. std Cat. III Q.H. narrow	Cat. I & II std Cat. II Q.H. std Cat. III Q.H. narrow
Hitch adjustment	4 position	4 position	4 position	2 position	2 position	2 position
Tractor requirement	15 - 30 hp	20 - 40 hp	22 - 40 hp	40 - 70 hp	60 - 90 hp	60 - 90 hp
Weight	422 lb	470 lb	515 lb	756 lb	848 lb	878 lb

SNOWBLOWER



HEAVY-DUTY MODELS 960 // 1080 // 1200

PRODUCT OVERVIEW

- Rear attach for use on acreages, farms and municipalities
- Category II, III
- 90 - 225 hp

FEATURES

- Spout rotator and deflector available as manual or hydraulic
- Standard shear bolt protection on all PTOs

OPTIONS

- Commercial and truck loader chute, 1080 & 1200 models

AVAILABLE COLORS



*Red is the standard color.



FARM KING SNOWBLOWERS ARE BUILT TO WORK HARD FOR MANY WINTERS TO COME.

Designed to be durable and rugged, Farm King Snowblowers offer excellent value in a snowblower that will stand the test of time. These heavy-duty snowblowers are available in widths ranging from 96" to 120".

The Farm King snowblower utilizes a powerful hydraulic motor to control the spout rotation. Using a motor to control rotation increases the blower's responsiveness and gives the operator a greater range of control over the placement of the snow. Standard on all heavy-duty models, a hand crank optional is available on model 960.

The spout rotator is available with manual or hydraulic positioning. Adjustable and replaceable skid shoes are standard on all models. A 4-blade fan is standard equipment on all models. Durable construction - 7 gauge auger flighting. The oil bath gearbox adds longevity. A 7' or 10.5' commercial truck loader chute is optional on the 1080 and 1200 models.



Model 960 - 96" (2.4 m) cutting width, 3-point hitch Category II / III
For tractors 90 - 125 hp

Model 1080 - 108" (2.7 m) cutting width, 3-point hitch Category II / III
For tractors 120 - 180 hp

Model 1200 - 120" (3 m) cutting width, 3-point hitch Category II / III
For tractors 180 - 225 hp

HEAVY WEIGHTED

With weights ranging from 1,243 lb to 2,600 lb Farm King Snowblowers are among the heaviest in their class, built with heavy-gauge steel to enhance durability. The gearbox is housed in a sealed oil bath that is resistant to heat, moisture and debris.

The PTO and sprocket to the main auger are protected from damage by shear bolts.

[1] Dual 15" augers work with a 4-blade fan to pull snow through quickly and evenly **[2]** A 7' or 10.5' commercial truck loader chutes are optional on the 1080 and 1200 models **[3]** Models 960, 1080 and 1200 utilize a powerful hydraulic motor to control the spout rotation **[4]** The hydraulically controlled hood deflector on the 1080 and 1200 provides for quick and simple adjustments on the fly.

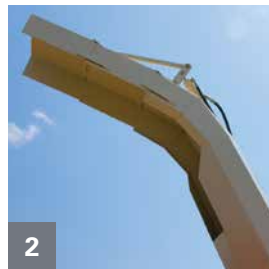

MODEL	960	1080	1200
Cutting width	96"	108"	120"
Cutting height	36"	41"	41"
Replaceable cutting edge	N/A	Yes	Yes
Fan	4-blade	4-blade	4-blade
Fan dimensions	32" x 9"	34" x 12"	34" x 12"
Replaceable fan housing	N/A	7 gauge	7 gauge
Drive fan	540 RPM oil bath gearbox	1000 RPM oil bath	1000 RPM oil bath
Auger diameter	15" (dual)	15" (dual)	15" (dual)
Auger drive	#60 chain	#80 chain	#80 chain
Spout rotator - manual (hand crank) - hydraulic cylinder	Optional Standard	N/A Standard	N/A Standard
Spout deflector - manual (6 position) - hydraulic cylinder	Standard Optional	N/A Standard	N/A Standard
Skid shoes	Adjustable and replaceable	Adjustable and replaceable	Adjustable and replaceable
Hitch category	Cat. II std Cat. II Q.H. std Cat. III Q.H. narrow	Cat. II std Cat. III Q.H. std Cat. III Q.H. narrow	Cat. II std Cat. III Q.H. std Cat. III Q.H. narrow
Hitch adjustment	Fixed	2 position	2 position
Tractor requirement	90 - 125 hp	120 - 180 hp	180 - 225 hp
Weight	1243 lb	2398 lb	2600 lb

FARM KING HAS BEEN BUILDING RELIABLE AGRICULTURAL AND COMMERCIAL SNOWBLOWERS FOR MORE THAN FOUR DECADES.



The design has stood the test of time through the years, while continuously refined to create the best line of snowblowers in the industry. The new Propeller blade from Farm King is the culmination of that expertise and experience.

WHAT SETS THE PROPELLER APART IS THE AGGRESSIVE BLADES ON A PADDLE-STYLE AUGER THAT MAXIMIZES PERFORMANCE IN EXTREME CONDITIONS WITH HEAVY, PACKED AND WET SNOW.

The rapid rotation of the auger with the propeller blades breaks down larger pieces of snow as it enters the machine and moves toward the fan, providing a smoother flow of snow into the fan.

Farm King Snowblowers are available in sizes ranging from 50" widths and up. Heavy-duty widths are also available ranging from 96" to 120".

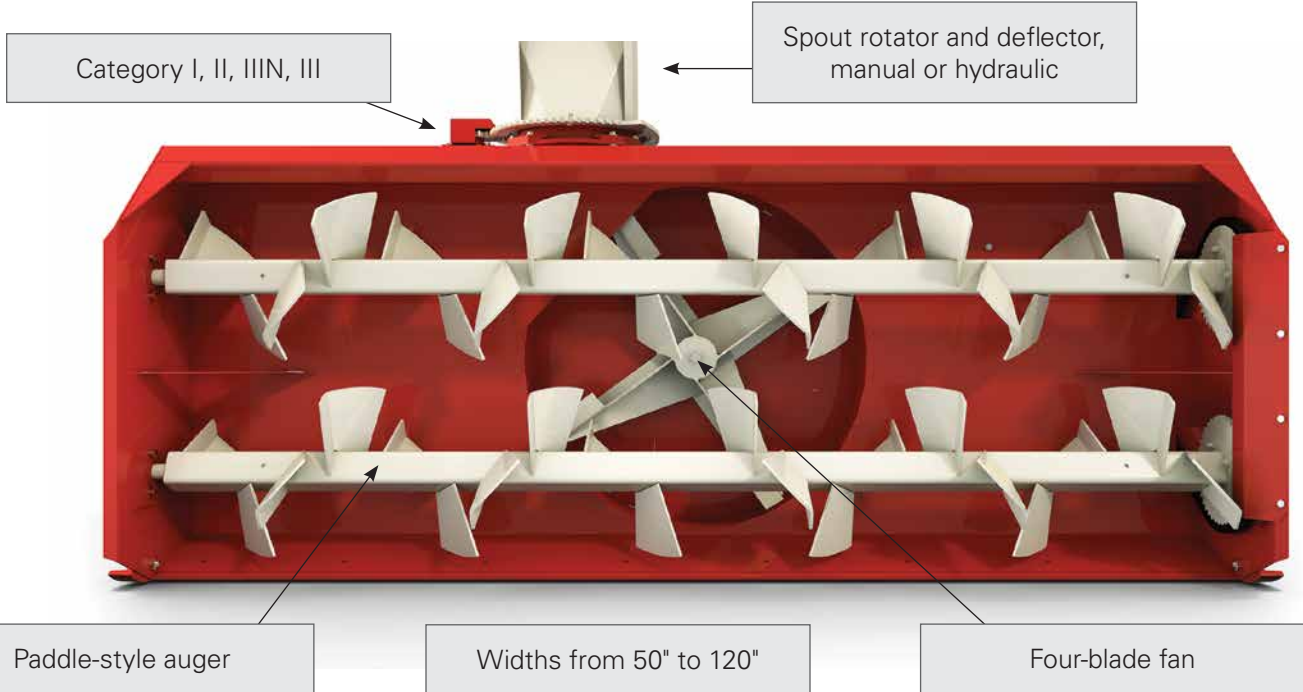



THE ALLIED BY FARM KING BINARY SNOWBLOWER OFFERS TWO IMPLEMENTS IN ONE MACHINE.

Farmers are making the most of their equipment assets and the new Allied by Farm King Hydraulic Snowblower offers the flexibility to be used on a skid steer or a tractor with a PTO and 3-point hitch. By removing a few bolts and changing some hardware, the hydraulic snowblower can be used on a traditional farm tractor. Allied by Farm King Binary Snowblowers are available in sizes ranging from 50" to 84" widths.

SPECIFICATIONS

MODEL	H500		H600		H660		H740		H840	
	Standard	High	Standard	High	Standard	High	Standard	High	Standard	High
Hydraulic flow										
Cutting width	50"		60"		66"		74"		84"	
Cutting height	24"		24"		24"		25"		25"	
Cutting edge	Replaceable opt.		Replaceable opt.		Replaceable opt.		Replaceable opt.		Replaceable opt.	
Mount plate	Universal		Universal		Universal		Universal		Universal	
Hydraulic requirements	17-23 gpm	23-26 gpm	17-23 gpm	23-26 gpm	17-23 gpm	23-26 gpm	17-23 gpm	23-26 gpm	17-23 gpm	23-26 gpm
Hydraulic horsepower, max	44 hp @ 3300 PSI	69 hp @ 3300 PSI	44 hp @ 3300 PSI	69 hp @ 3300 PSI	44 hp @ 3300 PSI	69 hp @ 3300 PSI	44 hp @ 3300 PSI	69 hp @ 3300 PSI	44 hp @ 3300 PSI	69 hp @ 3300 PSI
Fan speed, max	664 RPM	699 RPM	664 RPM	699 RPM	664 RPM	699 RPM	664 RPM	699 RPM	664 RPM	699 RPM
Fan torque, max	3350 ft-lb	521 ft-lb	3350 ft-lb	521 ft-lb	3350 ft-lb	521 ft-lb	3350 ft-lb	521 ft-lb	3350 ft-lb	521 ft-lb
Fan	4 blade		4 blade		4 blade		4 blade		4 blade	
Fan diameter	22"		22"		22"		23"		23"	
Fan drive motor	8.0 cuin	11.9 cuin	8.0 cuin	11.9 cuin	8.0 cuin	11.9 cuin	8.0 cuin	11.9 cuin	8.0 cuin	11.9 cuin
Fan drive	#80 Chain	#80HS	#80 Chain	#80HS	#80 Chain	#80HS	#80 Chain	#80HS	#80 Chain	#80HS
Auger diameter	15"		15"		15"		15"		15"	
Auger drive	#50 Chain		#50 Chain		#50 Chain		#50 Chain		#50 Chain	
Chute rotation	Hydraulic 270°		Hydraulic 270°		Hydraulic 270°		Hydraulic 270°		Hydraulic 270°	
Chute deflector	Hydraulic		Hydraulic		Hydraulic		Hydraulic		Hydraulic	
Skid shoes	Adjustable and replaceable		Adjustable and replaceable		Adjustable and replaceable		Adjustable and replaceable		Adjustable and replaceable	
Weight	480 lb		528 lb		573 lb		814 lb		906 lb	

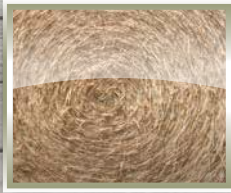
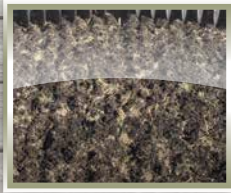

Farm King

For more information contact:

E-mail: info@buhler.com

www.farm-king.com

Equipment shown is subject to change without notice. ©2016 Buhler Trading Inc.
Printed in Canada. TSX:BUI Ref: 082016-5000-LM P/N: PLANDCOMP

bühler | a division of Buhler Industries Inc.