

NEW



COMPACT EXCAVATOR | 90z-1/100c-1

Operating weight: 18975/21458 lbs Net engine power: 70.2 hp



THE STRONGEST CONTENDER.

THE JCB 90Z AND 100C ARE QUITE SIMPLY THE TOUGHEST 9 TO 10-TON EXCAVATORS WE'VE EVER BUILT. USING THE FULL RANGE OF OUR 50-YEAR EXPERTISE, TALKED TO CUSTOMERS JUST LIKE YOU TO MAKE SURE THAT THESE MACHINES WILL MEET YOUR DEMANDS.

A simplified H-frame construction and finite element analysis have helped us to create the ultimate heavy-duty structure. The 90z and 100c therefore combine durability with confidence-inspiring stability.



Tough by design.

- 1 For added structural strength, our clean and elegant arm design is constructed from four plates.
- 2 The fully robot-welded high tensile steel boom and arm is strengthened with internal baffle plates to offer a long and trouble-free service life.
- 3 Bodywork is made using 100% high strength pressed steel so it's strong, durable and easy to repair, with no fragile plastic sections.



Dig end durability.

4 With a heavy-duty boom cylinder guard, and the option of arm and crowd ram guards, you can rest assured of maximum excavator arm protection, even during the toughest jobs.

5 Excavator hoses are safely routed through our heavy-duty swing bracket, which is made to last using durable re-bushable pivots.



The best build quality.

6 Fold back your cab door and you'll see that it fits snugly within the counterweight length. This keeps it out of harm's way while you're working.

7 Hydraulic seals are the very latest O-ring face seal (ORFS) type, ensuring a robust connectivity between joints.

8 To help these machines perform anywhere, we equip them with high quality 18" rubber tracks with interlocking links. Our optional 18"/24" steel tracks are fitted pre-drilled so you can attach rubber pads easily. Then you have the choice of dedicated Road Liner Pads (GeoGrip), which can be replaced segment-by-segment when they get worn.

9 Premium componentry comes as standard on the 90z and 100c. The spec list includes JCB Diesel by Kohler engines, Nachi and Bosch-Rexroth hydraulics, and Bridgestone tracks.



TOP PERFORMERS.

THE LATEST JCB 9 TO 10-TON COMPACT EXCAVATORS REPRESENT A HUGE LEAP FORWARD IN PERFORMANCE. PUT SIMPLY, IF YOU INVEST IN A 90Z OR 100C, YOU'LL GET UNSURPASSED LEVELS OF POWER, VERSATILITY AND PRODUCTIVITY.



1

Potent performance.

1 At the heart of these new JCB 10-tonne machines is a JCB Diesel by Kohler common rail Tier 4 final-compliant engine that's fitted with a Diesel Oxidation Catalyst, turbocharger and intercooler. Power has been increased to 73.8hp at 2000rpm, and the unit produces 225lbf ft of torque at 1500rpm.

2 You get class-leading tractive effort and tracking speed (2.7mph with a 100c and 2.9mph with a 90z) ensuring comprehensive dozer capabilities and swift travel times.

To increase productivity and reduce operator fatigue, our auto kickdown motors will automatically adapt to terrain changes.

Digging down.

3 There's a huge 188° bucket rotation, which helps to provide great spoil retention during truck loading. Both the 90z and 100c can also be equipped with your choice of arm length, from 5'5"-7'5".

4 3 arm lengths of 1.65m, 5'5", 6'11" and 7'5" per model gives increased performance and for more versatility.



2

ZTS or CTS?

Both ZTS and CTS tailswing configurations have distinct productivity advantages so you'll need to choose which setup suits your business best. CTS provides superior stability, lifting capacity and a larger dig end, while the absence of any track overhang on ZTS makes for greater maneuverability in tight spaces.



3



4

Easier ground levelling and efficient site clean-up is guaranteed with our dozer blade float option. Choose the angled dozer blade for the most efficient trench back-filling.

5 We've achieved optimal dig end geometry by carefully matching the boom and arm to each other. This superb balance helps you to operate with total ease in confined areas.

6 Dipper tearout forces are substantial (up to 11,218lbf on both the 90z and 100c), unrivalled productivity and fast cycle times are all part of the package.

Hydraulic innovation.

7 A high quality closed center pump and valve provides smooth and precise multifunctioning operation, as well as improved flow sharing.

Standard high and optional low flow auxiliary hydraulics enable you to operate all sorts of versatility-enhancing attachments. Proportional electronic control of the auxiliary lines with full adjustability means you can operate any attachment easily.

8 As an option the 90Z and 100C can be supplied as tilt rotate ready. Tiltrotate enhances your excavator's efficiency and overall productivity as it allows you to excavate, tilt, and rotate the bucket, or any other accessory, in one simultaneous operation.

Improved dozer design.

9 We've completely overhauled our dozer profile and angle so that performance is improved and soil retention is drastically reduced. Lift points are now tapered and situated behind the edge of the blade for added protection.



THE COMFORTABLE FAVORITE.

WE'VE MADE THE JCB 90Z AND 100C ERGONOMIC AND COMFORTABLE TO OPERATE. AFTER ALL, AN OPERATOR WHO'S FRESH AND ALERT ALL DAY LONG WILL ALWAYS ACHIEVE HEIGHTENED LEVELS OF PRODUCTIVITY.

A productive environment.

1 We've boosted overall space in our excavator cabs. This means there's plenty of storage, a phone tray, stowage net and a cup holder. A large door provides easy safe cab access.

2 Operators will find our standard-fit fully adjustable suspension seat very comfortable; they'll be even more impressed with our heated air suspension option, boasting independent adjustable positions for excellent ergonomics. An informative color LCD display is at the center of our intuitive switch layout, and you can even spec an optional reversing camera.

3 The 3-speed heater and window defroster on your 90z or 100c, with 9-adjustable air vents ensure a comfortable and productive working environment.

For added comfort a high performing air conditioning system is available as an option and there's also a radio and 12V phone charger.



Smoothly does it.

4 The hydraulic valve block is isolated from the chassis by rubber mounts, thus reducing in-cab noise and vibration. The valve block is nevertheless easy to access under the side-opening hood.

5 A standard-fit ergonomic electro-hydraulic dozer control ensures smooth and precise grading control.

6 Switching between single and double-acting auxiliary flow is easy with our convenient cab-mounted switch.

7 You can operate a huge variety of attachments seamlessly by toggling between 10 different electro proportional high flow line rates.

8 Short pitched tracks engage every tooth on the sprocket, helping to reduce vibration and noise whilst maintaining a very smooth ride on the JCB 90z and 100c.



SAFETY AND SERVICEABILITY.

A SAFE SITE IS OF PARAMOUNT IMPORTANCE TO ANY OWNER; LIKEWISE MACHINERY THAT'S EASY AND FAST TO SERVICE. BOTH THE 90Z AND 100C WILL PROTECT MACHINERY, OPERATORS AND BYSTANDERS ALIKE, AS WELL AS PROVIDING DOWNTIME - MINIMIZING SERVICEABILITY.

Safety first.

- 1 JCB's safety lever lock isolates hydraulic functions to prevent unintended movements.
- 2 To ensure that your hydraulics are only operated in a safe lockable position, JCB's unique 2GO system requires the operator to acknowledge they are ready to work.
- 3 There's a clear view of the front right track on both the JCB 90z and 100c, courtesy of a 70/30 front screen split. This makes trench digging and maneuvering safer.
- 4 Stability on these machines is best-in-class. Hardly surprising when you consider that both are blessed with a large track frame width and a low center of gravity.



Front screen guards can be specified to provide total peace of mind to operators. Standard boom and optional cab worklight guards are another option that protects vulnerable components during hazardous applications.

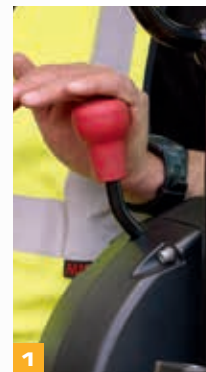
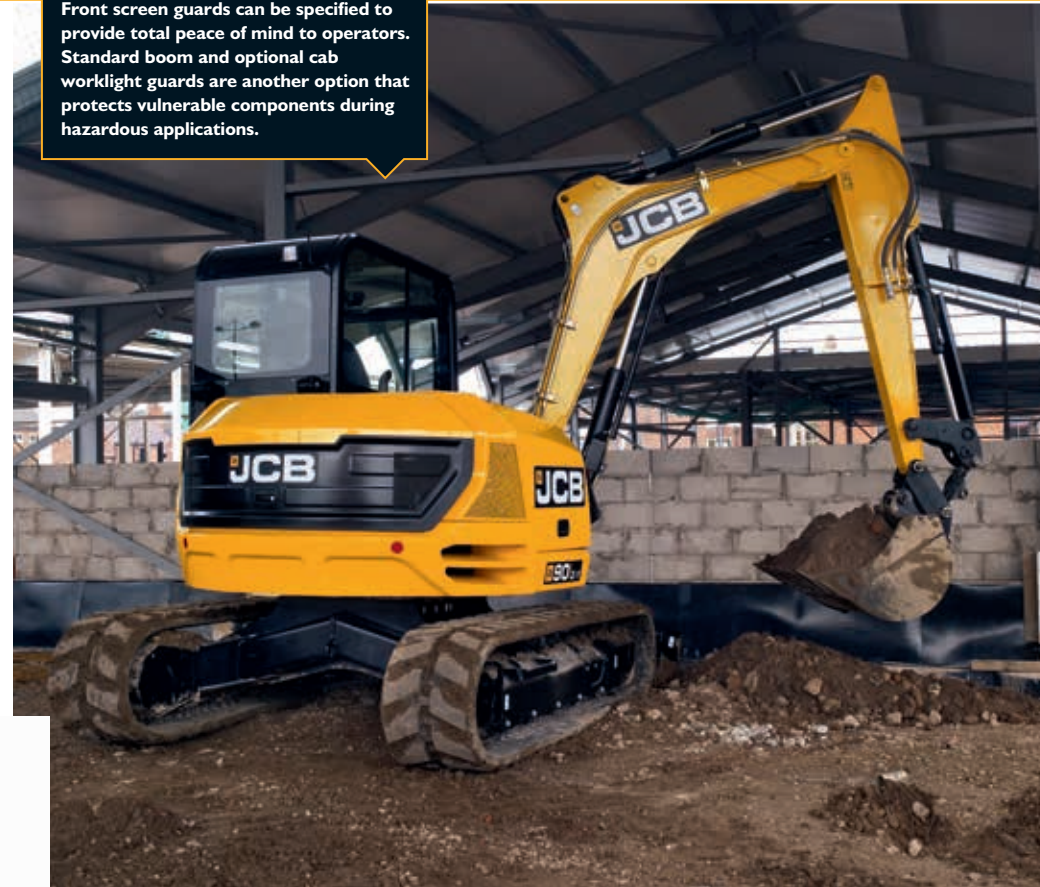

Excellent SAE service rating equates to greater uptime for both the JCB 90z and 100c. Our machines are more serviceable courtesy of features like a gas-strutted 30-degree tilting cab. You don't need special tools to operate this either, so routine checks are quicker to perform than ever.

Routine servicing.

- 5** Greasing intervals at the dozer and dig end are a best-in-class 500 hours, which saves you time and money. This is made possible because we use graphite impregnated bronze bushes.
- 5** Material build-up is prevented by a sealed idler tension unit and an open frame undercarriage design with sloping track legs. This means the 90z and 100c are easier to clean.
- 7** Key components like the rotary joint, swing cylinder, removable side skirts and in-fill panel are all easily accessed via the tilting cab.
- 5** For reduced fuel spillage and increased safety, fit your machine with JCB's optional refuelling pump with its auto stop function.

There are color-coded hydraulic hoses to make identification simple. Hoses from the dozer all terminate at the bulkhead, which means that replacing them is easy.

- 5** To make access safer and bodywork better-protected, we've fitted a cast anti-slip tread plate. Meanwhile, our two-piece floor mat is easy to remove for cleaning.



LOW COST OF OWNERSHIP.

With identical bucket pin geometry to the world leading JCB 3CX backhoe loader, attachments are fully interchangeable.

ENSURING A LOW COST OF OWNERSHIP IS FOREMOST IN OUR CUSTOMERS' MINDS. THAT'S WHY WE'VE BUILT THE JCB 90Z AND 100C TO KEEP RUNNING COSTS AFFORDABLE AND PRODUCTIVITY HIGH.

A great investment.

- 1** Fuel combustion in the JCB Diesel by Kohler engine is so clean that the unit doesn't require a diesel particulate filter (DPF). This reduces servicing, increases uptime and improves fuel efficiency.
- 2** Engine revs on your 90z or 100c automatically drop to 950 rpm when the operator's armrest is raised. This combined with the Auto Idle feature therefore reduces fuel economy and noise levels even further.
- 3** Auto Idle is programmable and can be set to activate after the controls have been unused for any period between 2 and 30 seconds.
- 4** The load-sensing hydraulics on JCB's 9 to 10-tonne excavators only consume power on demand, conserving fuel for when you need it most.
- 5** There are two separate dig modes (efficiency-boosting ECO or productivity-enhancing Heavy), allowing you to tweak your performance for any job.

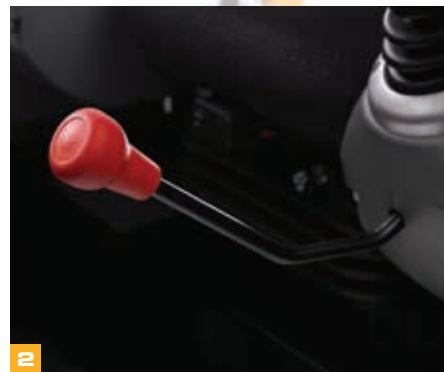

LIVELINK, WORK SMARTER.

JCB LIVELINK IS AN INNOVATIVE SOFTWARE SYSTEM THAT LETS YOU MONITOR AND MANAGE YOUR MACHINES REMOTELY – ONLINE, BY EMAIL OR BY MOBILE PHONE.

Productivity and cost benefits –

Machine location information can improve fleet efficiency and you may even enjoy reduced insurance costs courtesy of the added security that LiveLink brings.

** Note: Please consult your local dealer for LiveLink availability*

LIVELINK



Maintenance

benefits – Accurate hours monitoring, maintenance history records, critical machine alerts and service alerts improve maintenance planning.

Security benefits –

Real-time geofencing lets you set operating zones and curfew alerts that tell you when your machinery outside of pre-determined times. Location information helps you store machines safely.

VALUE ADDED.

JCB'S WORLDWIDE CUSTOMER SUPPORT IS FIRST CLASS. WHATEVER YOU NEED AND WHEREVER YOU ARE, WE'LL BE AVAILABLE QUICKLY AND EFFICIENTLY TO HELP MAKE SURE YOUR MACHINERY IS PERFORMING TO ITS FULL POTENTIAL.



1 Our Technical Support Service provides instant access to factory expertise, day or night, while our Finance and Insurance teams are always on hand to provide fast, flexible, competitive quotes.

JCB Premiercover offers comprehensive extended warranties and service agreements, as well as service-only or repair and maintenance contracts. Irrespective of what you opt for, our Maintenance teams around the world charge competitive labor rates, and offer non-obligation quotations as well as fast, efficient insurance repair work.



2 The global network of JCB Parts Centers is another model of efficiency; with 15 regional bases, we can deliver around 95% of all parts anywhere in the world within 24 hours. Our genuine JCB parts are designed to work in perfect harmony with your machine for optimum performance and productivity.

STATIC DIMENSIONS

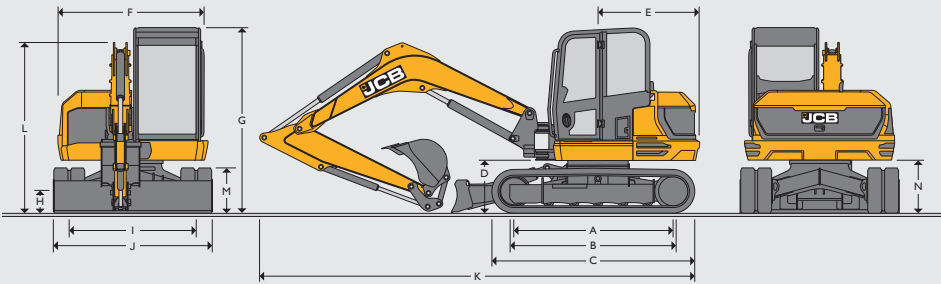

| Machine model | | 100c-1 | 90z-1 |
|---------------|---------------------------------------|--------|-----------------|
| A | Sprocket idler centers | ft-in | 7' 8" |
| B | Track length on ground | ft-in | 7' 8" |
| C | Undercarriage overall length – rubber | ft-in | 9' 8" |
| | Undercarriage overall length – steel | ft-in | 9' 6" |
| D | Swing bracket clearance | ft-in | 2' 7" |
| E | Tailswing radius | ft-in | 5' 3" 3' 9" |
| F | Overall width of superstructure | ft-in | 7' 2" |
| G | Height over cab | ft-in | 8' 11" |
| H | Ground clearance | ft-in | 1' 2" |
| I | Track gauge | ft-in | 6' 11" |
| J | Width over tracks (450 shoes) | ft-in | 7' 7" |
| K | Transport length with standard arm | ft-in | 22' 6" 21' 7" |
| L | Transport height with standard arm | ft-in | 8' 6" |
| M | Track height | ft-in | 2' 2" |
| N | Counterweight clearance | ft-in | 2' 6" |

ENGINE

| Machine model | | 100c-1 | 90z-1 |
|---------------|-------------------|---------------------------|-------|
| Model | | Tier 4 Final KDI 2504 TCR | |
| Fuel | | Diesel | |
| Cooling | | Water cooled | |
| Gross power | hp @ 2200 rpm | 73.8 | |
| Net power | hp @ 2200 rpm | 70.3 | |
| Gross torque | lbf-ft @ 1400 rpm | 225 | |
| Displacement | cubic inches | 152.56 | |
| Gradeability | % | 30 | |
| Starter motor | hp | 2.7 | |
| Battery | volt / amps | 12V / 75 CCA | |
| Alternator | volt / amps | 12V / 80A | |

UNDERCARRIAGE

| Machine model | | 100c-1 | 90z-1 |
|----------------------|-----|-----------|-------|
| No of top rollers | | 1 | |
| No of bottom rollers | | 5 | |
| Track width | in | 18" | |
| Track width optional | in | 18" / 24" | |
| Ground clearance | in | 14" | |
| Track tensioning | | Grease | |
| Travel speed – low | mph | 1.5 | 1.6 |
| Travel speed – high | mph | 2.7 | 2.9 |
| Tractive effort | lbf | 132 | 128 |

HYDRAULIC SYSTEM

| Machine model | | 100c-1 | 90z-1 |
|--------------------------------------|-----|--------|-------|
| Nominal output @ 2000rpm | gpm | 39.1 | |
| Excavator/track main relief pressure | psi | 4351 | |
| Slew main relief pressure | psi | 3278 | |
| Auxiliary low flow | gpm | 6.6 | |
| Auxiliary high flow | gpm | 26.4 | |
| Auxiliary low flow | psi | 2756 | |
| Auxiliary high flow | psi | 2756 | |
| Hydraulic motors | | Piston | |

WEIGHTS

| Machine model | | 100c-1 | 90z-1 |
|---------------------------------------|-----|--------|-------|
| Operating weight* (16" rubber tracks) | lbs | 21458 | 18975 |
| Shipping weight** (16" rubber tracks) | lbs | 21087 | 18605 |
| With FOGS guard – Stage 1 | lbs | +31 | |
| With FOGS guard – Stage 2 | lbs | +214 | |
| With FOGS guard – Stage1 HVAC | lbs | +108 | |
| With 16" steel tracks | lbs | +406 | |
| With 22" steel tracks | lbs | +809 | |
| With 16" Geo grip tracks | lbs | +295 | |
| Ground bearing pressure (16" tracks) | psi | 6.5 | 5.8 |
| Ground bearing pressure (22" tracks) | psi | 5.0 | 4.4 |
| With narrow dozer (2220mm) | lbs | -11 | |
| With wide dozer | lbs | +40 | |
| With 4 way dozer | lbs | +478 | |
| With long dipper (6' 7") | lbs | +35 | |
| With short dipper (5' 5") | lbs | -106 | |
| With quickhitch | lbs | +209 | |

*Operating weight to ISO 6016 including cab, rubber tracks, standard dipper, 24" bucket (90z), 35" (100c adding 95 lbs of weight), full tanks and a 165 lb operator.

** Shipping weight to ISO 6016 is mass of the base machine without an operator, with fuel level at 10% of tank capacity.

SERVICE CAPACITIES

| Machine model | | 100c-1 | 90z-1 |
|------------------|-----|--------|-------|
| Fuel tank | gal | 29.6 | |
| Engine coolant | gal | 3.2 | |
| Engine oil | gal | 3.0 | |
| Hydraulic system | gal | 31.2 | |
| Hydraulic tank | gal | 17.4 | |

OPERATOR STATION

| Machine model | | 100c-1 | 90z-1 |
|---|-------|--------|-------|
| Cab/canopy height | ft-in | 5' 1" | |
| Cab/canopy height with FOGS guard LEVEL 1 | ft-in | 5' 5" | |
| Cab/canopy height with FOGS guard LEVEL 2 | ft-in | 5' 8" | |
| Cab/canopy length | ft-in | 6' 4" | |
| Cab/canopy width | ft-in | 3' 5" | |
| Distance from seat base to roof | ft-in | 3' 8" | |
| Door aperture width | ft-in | 2' 0" | |

STANDARD EQUIPMENT

Tilting cab, Fully glazed TOPS certified cab with JCB Impact Protection front screen, 2 speed intermittent wiper with wash/wipe, Roof mounted worklights, 3 speed heater/defroster with 9 adjustable air vents, Color LCD display, Digital clock, Adjustable sunblind, Internal lockable toolbox, Cup holder, Coat hook, 12v accessory socket, Interior light, Full audio/visual warning systems, Radio ready kit, Auto idle throttle, Below idle system, 2 digging modes (Eco and Heavy), ISO servo controls with electro-hydraulic dozer lever, Electro-proportional thumb controlled high flow double acting auxiliary, 10 selectable auxiliary flow rates, Joystick mounted hammer switch, Electronic single/double acting auxiliary changeover valve, Neutral start, Full control isolation, "2 go" hydraulic isolation, Midback suspension seat, 2 piece removable floor mat, Beacon ready kit, Two speed tracking, Auto-kickdown track motors, 18" short pitch rubber tracks, Double element air cleaner, Heavy-duty alternator, Heavy-duty battery, Hydraulic slew braking with disc type park brake, ORFS hydraulics, Color coded hydraulic hoses, Bushed swing bracket, 500 hour dig end greasing intervals, Heavy duty boom cylinder guard, Protected boom worklight, 6' 11" arm, 2 position bucket tipping link – Speed and Power, Quick release auxiliary couplers, 100% steel bodywork, Dual pattern controls (ISO/SAE change-over).

OPTIONAL EQUIPMENT

Air-conditioning, FOGS guard stage 1 or 2, 18" or 24" steel tracks, 18" Geo Grip Road Liner tracks, Fan & chaff guards, Battery isolator (standard for EU), High back seat or deluxe heated high back air-suspension seat, Radio installation, Electro-proportional thumb controlled low flow auxiliary, Hose burst check valve lifting kit (dozer, boom & arm), Bucket-to-grab change over valve, Mechanical quickhitch, Hydraulic quickhitch, Hydraulic quickhitch ready pipework, General purpose digging buckets, Ditch/grading buckets, Hydraulic hammers, Rotating/strobe beacon, Travel alarm, White noise alarm, Face fan, Toolkit, Greasegun & cartridge, Fire extinguisher, Exterior cab mounted mirrors, Interior mirror, Electric refuelling pump, JCB Immobiliser (Unique key or keypad system), Dozer float, Angled dozer blade, Dual pattern controls (ISO/SAE change-over), Front screen guard (Fine or course), Twin pair of front LED roof mounted worklights, Short and long arm options, Thumb ready arm, LiveLink, Special paint options, Block heater 110/240V.



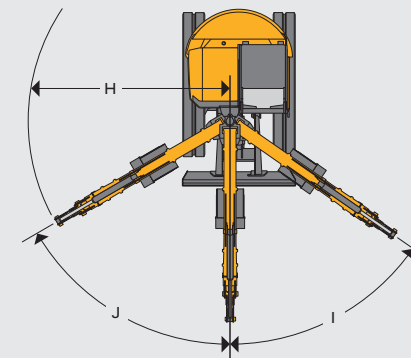
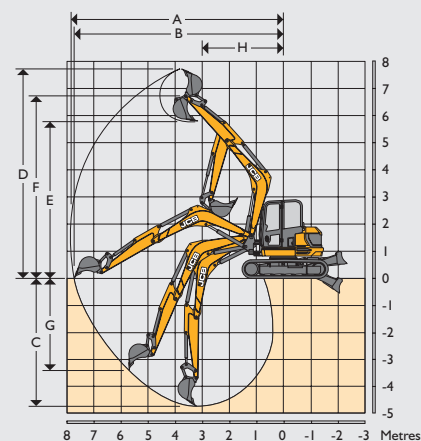











WORKING RANGE

































| | | 100c-1 | 90z-1 |
|--|---------|----------------------------|---------------------------|
| Arm length | ft-in | 5' 5" / 6' 11" / 7' 5" | 5' 5" / 6' 11" / 7' 5" |
| Boom length | ft-in | 12' 1" | 11' 0" |
| A Max. digging reach | ft-in | 23' 2" / 24' 6" / 24' 10" | 22' 9" / 24' 9" / 23' 7" |
| B Max. digging reach on ground | ft-in | 22' 7" / 24' 0" / 24' 5" | 22' 7" / 24' 9" / 24' 7" |
| C Max. digging depth - dozer up | ft-in | 13' 6" / 15' 0" / 15' 0" | 11' 7" / 13' 8" / 13' 6" |
| D Max. digging depth - dozer down | ft-in | 13' 6" / 14' 11" / 14' 11" | 11' 6" / 13' 7" / 13' 6" |
| E Max. digging height | ft-in | 23' 0" / 24' 0" / 24' 6" | 22' 6" / 23' 7" / 13' 11" |
| F Max. dump height | ft-in | 17' 0" / 18' 0" / 18' 7" | 16' 4" / 17' 5" / 17' 9" |
| G Max. height to arm nose pivot pin | ft-in | 20' 1" / 21' 1" / 21' 5" | 19' 5" / 20' 6" / 20' 10" |
| H Max. vertical wall digging depth | ft-in | 6' 2" / 7' 5" / 11' 6" | 10' 8" / 9' 6" / 12' 6" |
| I Min. front swing radius (no offset) | ft-in | 8' 10" / 9' 5" / 9' 6" | 9' 8" / 10' 2" / 10' 4" |
| J Min. front swing radius (fully offset) | ft-in | 7' 1" / 7' 9" / 7' 11" | 7' 9" / 8' 3" / 8' 5" |
| I Boom swing left | degrees | | 60 |
| J Boom swing right | degrees | | 60 |
| Bucket rotation | degrees | | 184.6 |
| Arm rotation | degrees | 118 | 114 |
| Bucket breakout force | lbf | 16231 | 12837 |
| Arm breakout force | lbf | 11218 / 9509 / 9060 | |
| Slew speed | rpm | 8.2 | 7.9 |

DOZER

| Machine model | | 100c-1 | 90z-1 |
|--------------------------|---------|--------|-------|
| Dozer length | ft-in | 4' 11" | |
| Max. height above ground | ft-in | 1' 7" | |
| Dig depth below ground | ft-in | 1' 6" | |
| Approach angle | degrees | 27.8 | |
| Width | ft-in | 7' 7" | |
| Height | ft-in | 1' 7" | |
| Reach in front of tracks | ft-in | 2' 0" | |

| LIFT CAPACITY – 18" RUBBER TRACKS, 12' 1" BOOM, 5' 5" ARM, NO BUCKET | | | | | | | | | | | | | | | | | 100C |
|--|---|---|---|---|---|---|---|---|---|---|---|---|---|---|---|----------|------|
| Load Point | 6' 7" | | | 9' 10" | | | 13' 1" | | | 16' 5" | | | Capacity at maximum reach | | | | |
| |  |  |  |  |  |  |  |  |  |  |  |  |  |  |  | Distance | |
| Height ft-in | Dozer Up lbs | Dozer Down lbs | Over Side lbs | Dozer Up lbs | Dozer Down lbs | Over Side lbs | Dozer Up lbs | Dozer Down lbs | Over Side lbs | Dozer Up lbs | Dozer Down lbs | Over Side lbs | Dozer Up lbs | Dozer Down lbs | Over Side lbs | ft-in | |
| 16' 5" | | | | | | | 4092* | 3878* | 4092* | | | | 4288 | 4061 | 3629 | 15' 4" | |
| 13' 1" | | | | | | | 4378* | 4149* | 4378* | 4204 | 3984 | 3280 | 3847 | 4008 | 2884 | 17' 10" | |
| 9' 10" | | | | 7297* | 6914* | 6781 | 5333* | 5053* | 4442 | 4321 | 4312 | 3219 | 3389 | 4041 | 2538 | 19' 3" | |
| 6' 7" | | | | | | | 5855 | 6228* | 4246 | 4224 | 4822 | 3131 | 3179 | 4120 | 2374 | 19' 11" | |
| 3' 3" | | | | | | | 5686 | 7086* | 4092 | 4134 | 5262* | 3047 | 3128 | 4220 | 2330 | 20' 0" | |
| 0' 0" | | | | 5730* | 5428* | 5730 | 5604 | 7315* | 4019 | 4076 | 5437 | 2994 | 3245 | 4341 | 2410 | 19' 5" | |
| -3' 3" | 6724* | 6371* | 6724* | 8891 | 9696* | 6069 | 5593 | 6969* | 4010 | 4065 | 5196 | 2983 | 3578 | 4453 | 2643 | 18' 1" | |
| -6' 6" | 12650* | 11984* | 12295 | 8633* | 8179* | 6144 | 5644 | 5966* | 4054 | | | | 4365 | 4517 | 3201 | 15' 9" | |
| -9' 10" | | | | 5591* | 5296* | 5591 | | | | | | | 4473 | 4237 | 4473 | 11' 8" | |





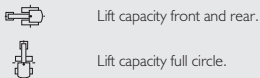









| LIFT CAPACITY – 18" RUBBER TRACKS, 12' 1" BOOM, 6' 11" ARM, NO BUCKET | | | | | | | | | | | | | | | | | 100C |
|---|---|---|---|---|---|---|---|---|---|---|---|---|---|---|---|----------|------|
| Load Point | 6' 7" | | | 9' 10" | | | 13' 1" | | | 16' 5" | | | Capacity at maximum reach | | | | |
| |  |  |  |  |  |  |  |  |  |  |  |  |  |  |  | Distance | |
| Height ft-in | Dozer Up lbs | Dozer Down lbs | Over Side lbs | Dozer Up lbs | Dozer Down lbs | Over Side lbs | Dozer Up lbs | Dozer Down lbs | Over Side lbs | Dozer Up lbs | Dozer Down lbs | Over Side lbs | Dozer Up lbs | Dozer Down lbs | Over Side lbs | ft-in | |
| 16' 5" | | | | | | | 3406* | 3228* | 3406* | 3737* | 3538* | 3380 | 3840 | 3638 | 3133 | 17' 2" | |
| 13' 1" | | | | | | | 3748* | 3549* | 3748* | 3759* | 3560* | 3369 | 3457 | 3640 | 2606 | 19' 4" | |
| 9' 10" | | | | 5798* | 5494* | 5798* | 4700* | 4453* | 4555 | 4180* | 3960* | 3296 | 3097 | 3697 | 2330 | 20' 8" | |
| 6' 7" | | | | 9235* | 8750* | 6477 | 5961 | 5692* | 4343 | 4290 | 4535* | 3192 | 2932 | 3785 | 2200 | 21' 4" | |
| 3' 3" | | | | 4634* | 4389* | 4634* | 5747 | 6762* | 4149 | 4180 | 5079* | 3089 | 2892 | 3896 | 2165 | 21' 4" | |
| 0' 0" | | | | 6651* | 6303* | 6005 | 5624 | 7273* | 4037 | 4101 | 5404* | 3016 | 2972 | 4019 | 2218 | 20' 10" | |
| -3' 3" | 6056* | 5739* | 6056* | 8818 | 10245* | 6008 | 5582 | 7194* | 3999 | 4068 | 5375* | 2985 | 3219 | 4160 | 2394 | 19' 7" | |
| -6' 7" | 10737* | 10170* | 10737* | 8887 | 9165* | 6067 | 5606 | 6526* | 4021 | 4087 | 4810* | 3003 | 3759 | 4281 | 2778 | 17' 6" | |
| -9' 10" | 11296* | 10703* | 11296* | 7346 | 6958* | 6197 | 5168 | 4896* | 4118 | | | | 4546 | 4308 | 3748 | 14' 1" | |















| LIFT CAPACITY – 18" RUBBER TRACKS, 12' 1" BOOM, 7' 5" ARM, NO BUCKET | | | | | | | | | | | | | | | | | 100C |
|--|---|---|---|---|---|---|---|---|---|---|---|---|---|---|---|----------|------|
| Load Point | 6' 7" | | | 9' 10" | | | 13' 1" | | | 16' 5" | | | Capacity at maximum reach | | | | |
| |  |  |  |  |  |  |  |  |  |  |  |  |  |  |  | Distance | |
| Height ft-in | Dozer Up lbs | Dozer Down lbs | Over Side lbs | Dozer Up lbs | Dozer Down lbs | Over Side lbs | Dozer Up lbs | Dozer Down lbs | Over Side lbs | Dozer Up lbs | Dozer Down lbs | Over Side lbs | Dozer Up lbs | Dozer Down lbs | Over Side lbs | ft-in | |
| 16' 5" | | | | | | | | | | 3543* | 3355* | 3415 | 3715 | 3519 | 3000 | 17' 9" | |
| 13' 1" | | | | | | | 3527* | 3342* | 3527* | 3609* | 3419* | 3397 | 3340 | 3534 | 2524 | 19' 11" | |
| 9' 10" | | | | | | | 4478* | 4242* | 4478* | 4045* | 3834* | 3322 | 3016 | 3596 | 2273 | 21' 2" | |
| 6' 7" | | | | 5307* | 5029* | 5307* | 5805* | 5501* | 4378 | 4314 | 4429* | 3214 | 2857 | 3684 | 2150 | 21' 9" | |
| 3' 3" | | | | 8710* | 8252* | 6561 | 5774 | 6632* | 4173 | 4198 | 5007* | 3106 | 2820 | 3794 | 2112 | 21' 10" | |
| 0' 0" | | | | 5505* | 5216* | 5505* | 5635 | 7231* | 4048 | 4112 | 5375* | 3025 | 2895 | 3922 | 2163 | 21' 3" | |
| -3' 3" | 5836* | 5527* | 5836* | 6839* | 6479* | 6008 | 5582 | 7240* | 3999 | 4070 | 5408* | 2987 | 3113 | 4054 | 2317 | 20' 1" | |
| -6' 7" | 10049* | 9520* | 10049* | 8801 | 9912* | 5994 | 5595 | 6671* | 4012 | 4081 | 4952* | 2998 | 3594 | 4189 | 2661 | 18' 1" | |
| -9' 10" | 12368* | 11718* | 12229 | 8863 | 9445* | 6045 | 5542* | 5251* | 4096 | | | | 4500 | 4262 | 3488 | 14' 10" | |

















Notes:

- Lifting capacities are based on ISO 10567, that is: 75% of minimum tipping load or 87% of hydraulic lift capacity, whichever is the less. Lifting capacities marked* are based on hydraulic capacity.
- Lift capacities assume that the machine is on firm level ground and equipped with an approved lifting point.
- A bucket must be fitted when lifting, the weight of this bucket must be deducted from the above lift capacities.
- Lift capacities may be limited by local regulations. Please refer to your dealer.

| LIFT CAPACITIES – 18" RUBBER TRACKS, 11' 0" BOOM, 5' 5" ARM, NO BUCKET | | | | | | | | | | | | | | | | | 90Z |
|--|---|---|--|---|---|--|---|---|--|---|---|--|---|---|--|-------------------|-----|
| Load Point | 6' 7" | | | 9' 10" | | | 13' 1" | | | 16' 5" | | | Capacity at maximum reach | | | | |
| Height ft-in |  Dozer Up lbs |  Dozer Down lbs |  Over Side lbs |  Dozer Up lbs |  Dozer Down lbs |  Over Side lbs |  Dozer Up lbs |  Dozer Down lbs |  Over Side lbs |  Dozer Up lbs |  Dozer Down lbs |  Over Side lbs |  Dozer Up lbs |  Dozer Down lbs |  Over Side lbs | Distance ft-in | |
| 16' 5" | | | | | | | 3206* | 3668* | 3082 | | | | 3338 | 3821 | 2701 | 14' 2" | |
| 13' 1" | | | | | | | 3177* | 3638* | 3062* | 3060 | 3649* | 2141 | 2917 | 3691 | 2039 | 16' 10" | |
| 9' 10" | | | | 4711* | 5393* | 4539* | 3726* | 4266* | 2976 | 3029 | 3785* | 2112 | 2511 | 3691 | 1750 | 18' 5" | |
| 6' 7" | | | | 6543 | 8056* | 4235 | 4147 | 5218* | 2822 | 2954 | 4169* | 2046 | 2335 | 3748 | 1620 | 19' 2" | |
| 3' 3" | | | | 4026* | 4608* | 3880* | 3990 | 6021* | 2685 | 2879 | 4537* | 1978 | 2291 | 3829 | 1583 | 19' 2" | |
| 0' 0" | | | | 6171 | 7624* | 3929 | 3904 | 6316* | 2612 | 2829 | 4683* | 1933 | 2388 | 3929 | 1645 | 18' 6" | |
| -3' 3" | 6171* | 7064* | 5948* | 6193 | 8629* | 3946 | 3891 | 6025* | 2599 | 2824 | 4365* | 1931 | 2674 | 4017 | 1834 | 17' 1" | |
| -6' 7" | 9286* | 10628* | 8089* | 6124* | 7008* | 4021 | 3946 | 4899* | 2650 | | | | 3393 | 3973 | 2306 | 14' 7" | |
| -9' 10" | | | | | | | | | | | | | | | | | |

| LIFT CAPACITY – 18" RUBBER TRACKS, 11' 0" BOOM, 6' 11" ARM, NO BUCKET | | | | | | | | | | | | | | | | | 90Z |
|---|---|---|--|---|---|--|---|---|--|---|---|--|---|---|--|-------------------|-----|
| Load Point | 6' 7" | | | 9' 10" | | | 13' 1" | | | 16' 5" | | | Capacity at maximum reach | | | | |
| Height ft-in |  Dozer Up lbs |  Dozer Down lbs |  Over Side lbs |  Dozer Up lbs |  Dozer Down lbs |  Over Side lbs |  Dozer Up lbs |  Dozer Down lbs |  Over Side lbs |  Dozer Up lbs |  Dozer Down lbs |  Over Side lbs |  Dozer Up lbs |  Dozer Down lbs |  Over Side lbs | Distance ft-in | |
| 16' 5" | | | | | | | 2619* | 2998* | 2524* | | | | 2956 | 3384 | 2264 | 16' 2" | |
| 13' 1" | | | | | | | 2701* | 3091* | 2604* | 2798* | 3203* | 2229 | 2575 | 3340 | 1812 | 18' 6" | |
| 9' 10" | | | | | | | 3265* | 3737* | 3075 | 3016* | 3452* | 2183 | 2277 | 3364 | 1598 | 19' 11" | |
| 6' 7" | | | | 5970* | 6832* | 4422 | 4145* | 4744* | 2908 | 3018 | 3904* | 2103 | 2138 | 3428 | 1493 | 20' 6" | |
| 3' 3" | | | | 6338 | 7571* | 4065 | 4054 | 5710* | 2743 | 2923 | 4370* | 2019 | 2099 | 3512 | 1459 | 20' 7" | |
| 0' 0" | | | | 6169 | 7972* | 3926 | 3931 | 6248* | 2635 | 2853 | 4661* | 1956 | 2172 | 3622 | 1504 | 20' 0" | |
| -3' 3" | 5280* | 6043* | 5088* | 6146 | 9162* | 3907 | 3885 | 6230* | 2595 | 2824 | 4610* | 1931 | 2372 | 3719 | 1636 | 18' 8" | |
| -6' 7" | 9127* | 10446* | 7904 | 6206 | 7970* | 3957 | 3909 | 5553* | 2617 | 2862 | 3836* | 1962 | 2840 | 3777 | 1949 | 16' 6" | |
| -9' 10" | 7410* | 8481* | 7143* | 4784* | 5474* | 4092 | | | | | | 3150 | 3150 | 3605 | 2837 | 12' 9" | |

| LIFT CAPACITY – 18" RUBBER TRACKS, 11' 0" BOOM, 7' 5" ARM, NO BUCKET | | | | | | | | | | | | | | | | | 90Z |
|--|---|---|--|---|---|--|---|---|--|---|---|--|---|---|--|-------------------|-----|
| Load Point | 6' 7" | | | 9' 10" | | | 13' 1" | | | 16' 5" | | | Capacity at maximum reach | | | | |
| Height ft-in |  Dozer Up lbs |  Dozer Down lbs |  Over Side lbs |  Dozer Up lbs |  Dozer Down lbs |  Over Side lbs |  Dozer Up lbs |  Dozer Down lbs |  Over Side lbs |  Dozer Up lbs |  Dozer Down lbs |  Over Side lbs |  Dozer Up lbs |  Dozer Down lbs |  Over Side lbs | Distance ft-in | |
| 16' 5" | | | | | | | | | | 2795* | 3199* | 2240 | 2853 | 3265 | 2152 | 16' 9" | |
| 13' 1" | | | | | | | 2535* | 2903* | 2445* | 2679* | 3067* | 2255 | 2485 | 3236 | 1750 | 19' 0" | |
| 9' 10" | | | | | | | 3102* | 3549* | 2989* | 2915* | 3336* | 2207 | 2209 | 3267 | 1552 | 20' 4" | |
| 6' 7" | | | | 5609* | 6418* | 4489 | 3995* | 4570* | 2939 | 3040 | 3807* | 2123 | 2077 | 3331 | 1453 | 21' 0" | |
| 3' 3" | | | | 6385 | 8715* | 4105 | 4079 | 5587* | 2765 | 2941 | 4301* | 2035 | 2044 | 3419 | 1424 | 21' 1" | |
| 0' 0" | | | | 6180 | 8111* | 3933 | 3944 | 6199* | 2646 | 2864 | 4634* | 1964 | 2105 | 3525 | 1462 | 20' 6" | |
| -3' 3" | 5040* | 5769* | 4859* | 6135 | 9284* | 3900 | 3887 | 6270* | 2597 | 2829 | 4451* | 1933 | 2286 | 3629 | 1581 | 19' 3" | |
| -6' 7" | 8488* | 9714* | 7848 | 6186 | 8232* | 3940 | 3900 | 5710* | 2608 | 2848 | 4074* | 1951 | 2703 | 3713 | 1858 | 17' 1" | |
| -9' 10" | 8351* | 9557* | 8049* | 5245* | 6001* | 4061 | 3444* | 3942* | 2707 | | | | 3146 | 3600 | 2584 | 13' 7" | |

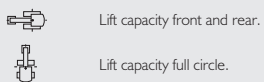

Notes:

- Lifting capacities are based on ISO 10567, that is: 75% of minimum tipping load or 87% of hydraulic lift capacity, whichever is the less. Lifting capacities marked* are based on hydraulic capacity.
- Lift capacities assume that the machine is on firm level ground and equipped with an approved lifting point.
- A bucket must be fitted when lifting, the weight of this bucket must be deducted from the above lift capacities.
- Lift capacities may be limited by local regulations. Please refer to your dealer.



ONE COMPANY, OVER 300 MACHINES.

Compact Excavator 90Z-1/100C-1

Operating weight: 18975/21458 lbs Net engine power: 70.2hp

JCB North American – Headquarters

Savannah. 2000 Bamford Blvd., Savannah, Georgia, 31322 Tel: (912) 447-2000

Download the very latest information on this product range at www.jcb.com

JCB inc. All rights reserved. No part of this publication may be reproduced, stored in a retrieval system, or transmitted in any form or by any other means, electronic, mechanical, photocopying or otherwise, without prior permission from JCB inc. All references in this publication to operating weights, sizes, capacities and other performance measurements are provided for guidance only and may vary dependant upon the exact specification of machine. They should not therefore be relied upon in relation to suitability for a particular application. Guidance and advice should always be sought from your JCB Dealer. JCB reserves the right to change specifications without notice. Illustrations and specifications shown may include optional equipment and accessories. The JCB logo is a registered trademark of J.C. Bamford Excavators Ltd.

Your nearest JCB Dealer

